

DOORS



Home Exteriors & Window Company

Call us TODAY!

(412)885-1900

2020

DOORS

ENTRY | PATIO | STORM



PROVIA BUILDS DOORS THE PROFESSIONAL WAY

ProVia has developed a competitive position by catering to a niche within the door market that demands a high degree of customization coupled with outstanding quality. Our company defines the products that meet this demand as "professional-class." We have found success by adhering to a set of core values that guide us as we develop rewarding, long-term relationships with our employees, customers and homeowners.

OUR MISSION:

— TO SERVE, BY CARING FOR —
DETAILS
IN WAYS OTHERS WON'T

IT HAS LED US TO EXACTING STANDARDS

If you ask around, you'll find attention to detail is what our customers have come to appreciate and expect from the ProVia brand. Our company is family-owned and faith-based with an intense focus on producing Professional-Class products. ProVia feels so strongly about the performance and workmanship of our entry system—built by skilled craftspeople with state-of-the-art manufacturing processes—that it's backed with a Lifetime Limited Warranty. The warranty is even transferable to one subsequent owner. You can visit our website provia.com for details. We're building your doors and our company to last a lifetime - that's **THE PROFESSIONAL WAY**.

INDUSTRY ASSOCIATION

ProVia is a proud member of the Window and Door Manufacturers Association (WDMA) and American Architectural Manufacturers Association (AAMA) - leading voices in our industry. As such, we support advocacy in building code and ASTM standard arenas, quality materials, installation and design in Doors and Windows.



WHAT IS A PLATINUM DEALER?

As the manufacturer, our Platinum Dealers mean a lot to us. We believe they greatly benefit you as a homeowner with their vast experience to expertly guide you through the exciting process of selecting the perfect new ProVia product for your home.

Platinum is a performance-based recognition program for companies who have demonstrated the highest level of commitment to selling and installing ProVia products. You couldn't ask for a better partner in making your purchase.

WHAT MAKES PROVIA® PROFESSIONAL-CLASS?

ENTRY SYSTEMS TAILORED FOR YOUR HOME

Today's off-the-rack consumer-grade doors, which are cut down to fit your need, often fall short of expectations and performance. This shortcoming is precisely the driving force behind why every ProVia door is built to your home's exact measurements – for a better fit and a more secure and energy efficient door. The materials and workmanship that go into custom-made doors are of exceptional quality and durability, and far exceed what is available as ready-made.

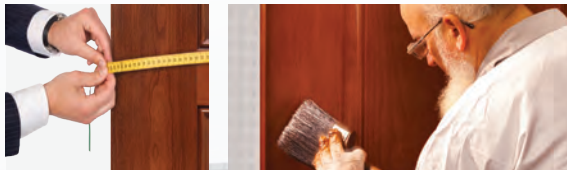

HIGHEST STANDARDS

ProVia is committed to making doors individually customized for homeowners to the highest standards of durability, security and energy efficiency in the residential market. A clear difference so defining that it has established a new category of professional-class doors, a better alternative to consumer-grade doors.

SECURITY | We focus on the strength and security of every door so you can focus on what's really important - your life.

DURABILITY | Made with the finest materials and backed by our Lifetime Limited Transferable Warranty, our durability can't be beat.

BEAUTY | A beautiful ProVia entry system will always greet your guests with classic elegance and style.

ENERGY EFFICIENCY | Engineered to keep the elements at bay and your home comfortable all year long.

ENTRY DOORS

DOOR TYPE

Components.....	14
Embarq® Fiberglass Features.....	18
Signet® Fiberglass Features.....	22
Heritage™ Fiberglass Features.....	24
Legacy™ Steel Features.....	26
8' Doors.....	28
French Doors.....	30
Inscribed Doors.....	32
Doors Without Glass.....	34

GLASS

ComforTech™ Glazing Systems

ComforTech Benefits.....	36
--------------------------	----

Decorative Glass

Mirage.....	40
Brookhaven.....	42
Manhattan.....	44
Essence.....	46
Cheyenne.....	48
Symphony.....	50
Berkley.....	52
Laurence.....	54
Carrington.....	56
Tacoma.....	58
Somerset.....	60
Carmen.....	62
Barcelona.....	64
Constance.....	66
Tranquility.....	68
Gemstone.....	70
Eclipse.....	72
Florence.....	74
Esmond.....	76
Carlisle.....	78
Twilight.....	80

Dialogue Layered Glass™

Brainstorm.....	82
Repartee.....	84

Inspirations™ Art Glass.....

Privacy Glass.....

Clear Glass.....

Clear Glass.....	90
White Internal Blinds.....	92
Colored Internal Blinds.....	94
Simulated Divided Lites.....	96
Internal Grids.....	98
External Grids.....	101

FINISHING TOUCHES

Stain Finishes.....	102
Paint Finishes.....	106
Trending/Custom Colors.....	108
Hardware.....	110
Speakeasy, Hinge Straps, Clavos.....	128
Pet Doors.....	130
Casing.....	131
Cladding.....	131

PATIO DOORS

Hinged Patio Doors.....	132
Vinyl Sliding Patio Doors.....	134

STORM DOORS

Features and Benefits.....	140
Spectrum™.....	142
Decorator™.....	144
Deluxe™.....	146
DuraGuard™.....	148
Superview™.....	150
Hardware.....	152
Accessories.....	156

IMPACT SHIELD PRODUCTS

About Impact Shield Products.....	158
Available Styles.....	160

Door Type

Glass

Finishing Touches

Patio Doors

Storm Doors

Impact Shield

THE PROFESSIONAL WAY

ProVia® has developed a competitive position by catering to a niche market that demands a high degree of customization coupled with superior quality. You will find attention to detail is what our customers have come to appreciate and expect from us. We're building your doors and our company to last a lifetime...that's **The Professional Way**.

**11
TIME**

Partner of the
Year Award



90%+ of Windows and Doors
are ENERGY STAR®
Certified

40+ Professional-Class
Exterior Building
Product Lines

DOORS | WINDOWS | SIDING | STONE | ROOFING



6 Facilities in the United States

900+

Associates Nationwide

Our Mission:

— TO SERVE, BY CARING FOR —
DETAILS
IN WAYS OTHERS WON'T

Doing Business Since

1977

19

Core Values

200+

Metric Tons of CO²
Saved Annually

1,900+

Tons of metals, paper, glass and vinyl
recycled annually at ProVia facilities

Visit provia.com to explore all of our products and options or
download the app.





STYLE YOUR WAY

TAILORED **JUST FOR YOU** AT THE HIGHEST STANDARDS.

SECURITY | DURABILITY | BEAUTY | ENERGY EFFICIENCY

We make it easy for you to make the choice that's right for you. When you combine your selected door style, door glass, paint or stain finish, plus hardware and accessories, the end result is a customized entryway that reflects your personalized style.



CRAFTSMAN STYLE



ARCHITECTURAL CHARACTERISTICS

AMERICAN CRAFTSMAN

Select attributes of this home style:

- Low-pitched roof lines, usually done in a hip or gable (triangular) style
- Occasional wide, overhanging eaves
- A covered front porch
- Pillars lining the entry
- Double hung windows
- Single, protruding dormers

INSPIRATION

DOOR STYLES



420



419



440

GLASS



Laurence

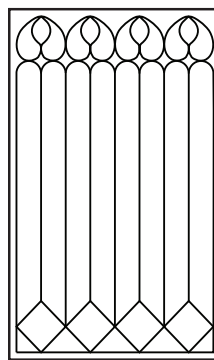

Cambria

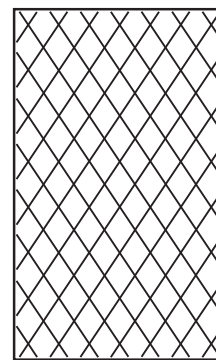

Westin



Carrington

FINISHES

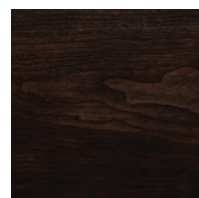

Coffee Bean



Sterling Gray

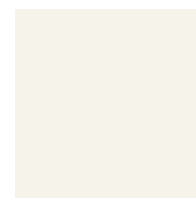

Cafe Cream

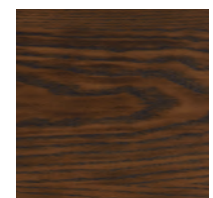

Truffle



MODERN STYLE



ARCHITECTURAL CHARACTERISTICS

MODERN/CONTEMPORARY

Select attributes of this home style:

- Asymmetrical footprint and floor plan
- Exaggerated roof lines and slopes
- Mix of building materials
- Custom built to client specifications
- Each home is unique to its environment
- Irregular colors

INSPIRATION

DOOR STYLES



001-INL6

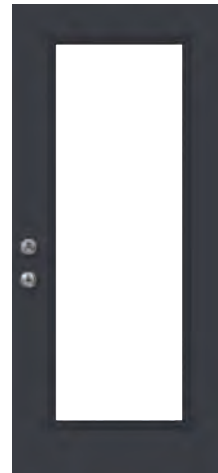

460



115

GLASS



Mirage



Manhattan



Repartee



Brainstorm

FINISHES

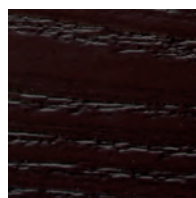

Dark Mahogany



Nightfall

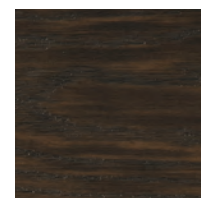

Espresso



Coal Black



COLONIAL STYLE



ARCHITECTURAL CHARACTERISTICS

CLASSIC/COLONIAL

Select attributes of this home style:

- Square or rectangle shape, with the door located in the center and the same number of windows reflected on either side
- High-peaked roof
- Central or end chimneys
- Pillars, dormer windows and brick detailing (mostly in later period homes)

INSPIRATION

DOOR STYLES



006



350



008P

GLASS



Somerset



Constance



Carlisle

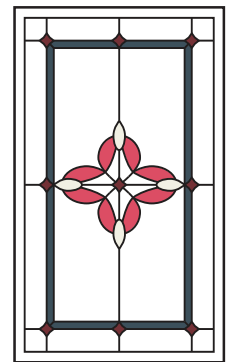

Haven

FINISHES



Mountain Berry

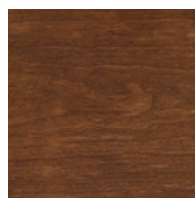

American Cherry



Enzian Blue

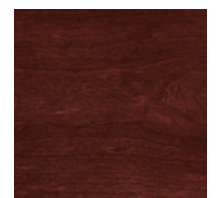

Cinnamon

DESIGN YOUR DREAM ENTRYWAY

WITH PROVIA'S EXTERIOR HOME DESIGN TOOLS

Find inspiration for the exterior of your home.

Download ProVia's free app for iPad or try the online Visualizer at provia.com/visualizer.



PROVIA VISUALIZER

Use ProVia's Visualizer to change the colors and styles of your home's doors, windows, siding, stone, and roofing

Let your imagination run free with this exterior home design tool. Select from a library of existing home styles, choosing one to match yours, or upload a photo of your own home.

In a few easy steps, update your siding color, add manufactured stone or a metal roof, give the windows a fresh look or personalize a new entry door.

Not sure where to start? Apply one of our pre-selected Designer Collections, then further customize the selections to reflect your own personal style.



PROVIA APP

Use the ProVia app to configure doors and windows or select from an extensive collection of vinyl siding, manufactured stone and metal roofing styles.

FEATURES

Door and Window Configurator

Vinyl Siding Profiles, Colors and Accessory Accents

Manufactured Stone Styles, Color Palettes and Grout Options

Metal Roofing Profiles, Trims and Colors

View Videos, Photo Galleries and Catalogs

Locate a ProVia Dealer





SHOW US YOUR STYLE AND CONNECT WITH US!

We love seeing how you apply our products to your home. Share photos with us.



DESIGN IT YOUR WAY

Imagine Your Entryway With a New Look. ProVia offers you endless possibilities to create the new front door of your dreams. To simplify the experience, we've categorized the selection process here to get you started. These ideas are just the beginning – you'll discover a myriad of additional color and style options throughout this catalog.

DOOR SKIN

Fiberglass and Steel door skins are available in a variety of textured and smooth options.

SIGNET SKIN OPTIONS



EMBARQ SKIN OPTIONS



LEGACY SKIN OPTIONS

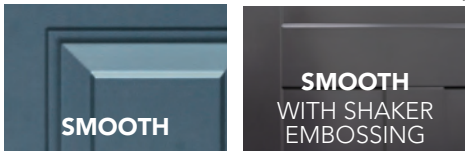

HERITAGE SKIN OPTIONS



CONFIGURATION

Find and customize a configuration that best fits the opening of your home.



DOOR STYLE

Your home should reflect your personality. That's why you'll find a wide selection of styles to suit your taste.



GLASS

Select from a full line of Decorative Glass, Inspirations™ Art Glass, Dialogue Layered™ Glass, Clear Glass, Privacy Glass, Simulated Divided Lites and Grid Styles.



FINISH

Our stain and glazed finishes are hand-applied by professional craftsmen, then oven-cured for maximum beauty. Paint finishes are factory applied for a long-lasting, durable finish.

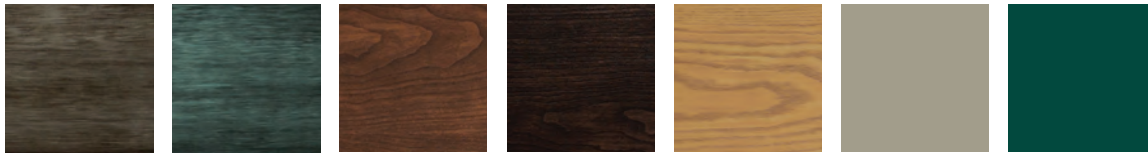

HARDWARE

Hardware from Trilennium®, Hoppe®, Emtex®, Brinks® and Schlage® provide some of the most stylish, durable hardware available today.



ACCESSORIES

Sometimes the smallest things make the biggest difference. Our accessories add a lot to the look of your entry system.



Colonial Door Knocker

Classic Door Knocker

Classic Door Knocker/Viewer

7/8\"/>

Mail Slot or Magazine Slot

Kick Plate

ADD A STORM DOOR

Protect, enhance and ventilate your entryway with a storm door, while adding an extra measure of security.



THE COMPONENTS

The components are the small things that set our doors apart from the competition. A lot of small things add up to a big difference.



440TAC-2P, 140TAC

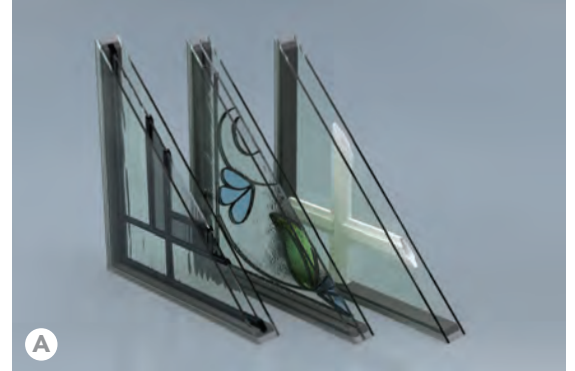

Your home is unique and deserves to have **custom glass options** like our ComforTech™ Warm Edge Glazing Systems which include decorative glass, Inspirations™ Art glass, internal blinds and internal and external grids in many grid patterns and colors.

 Impact Shield doors feature laminated glass.

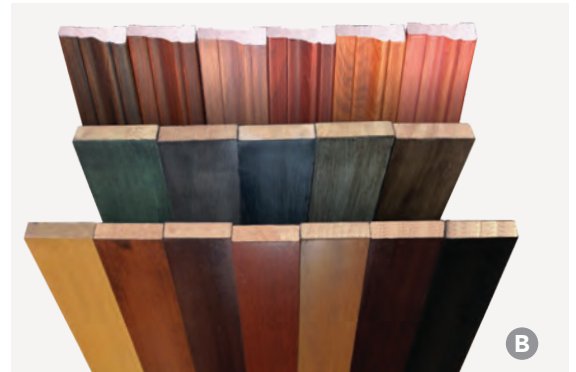

Our **2½" casing** conveniently covers paint lines providing a professional installation. **Also available in 3½"**. Choose from Cherry, Mahogany, Oak and Poplar. Flat Fir and Poplar trim are available in paint, stain and glazed finishes.

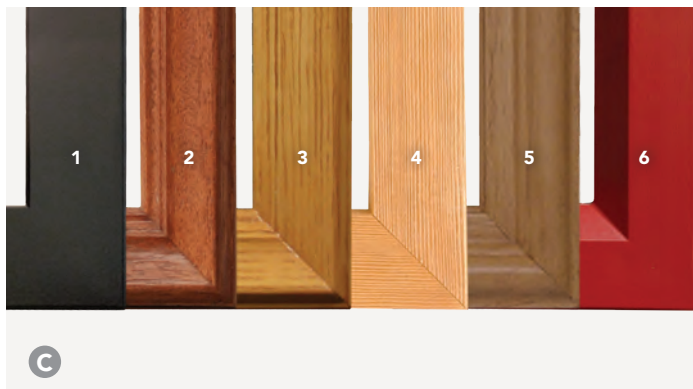

High-performance, heat-resistant window trim is warranted not to warp, crack or pull away from the door, even in sunny or higher temperature applications. **Plugless window trim** is standard on Embarq® and Signet® and optional for Heritage™† and Legacy™†.

1. Smooth (standard on select Signet Smooth doors and sidelites, optional on select Heritage Smooth and Legacy Smooth doors and sidelites) **2.** Embarq and Signet Cherry and Mahogany **3.** Embarq and Signet Oak and Knotty Alder **4.** Signet Fir **5.** Heritage and Legacy **6.** Modern Flat Trim (only available on models 112, 114, 115, 116 and 160 sidelites)

† See price list for available styles.

 Impact Shield doors have aluminum window trim.



The **Z-AC™ threshold** has an auto-adjusting riser and built-in sealing system that redefines how your door can perform for you. Standard on Signet and Legacy.

- **Automatically adjusts** to your entry door's changing needs over time, eliminating service calls
- Delivers **non-stop protection** against air and water infiltration
- **Saves money** and provides an improved door experience

The **ZAI™ threshold** has a manually-adjustable riser with complementary screw cover caps. Standard on Heritage.

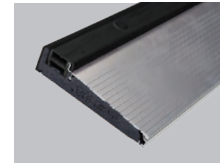

Three **heavy-duty ball bearing hinges** come standard with every entry system.

Additional 4th hinge option for greater durability. (only available with FrameSaver®)

 Impact Shield doors have heavy-duty stainless steel hinges.



The energy efficient **weatherstripping** runs along the top and sides of the door and interlocks with the **CornerShield™** for the most efficient seal you'll find for keeping moisture, wind and dirt out of your home.

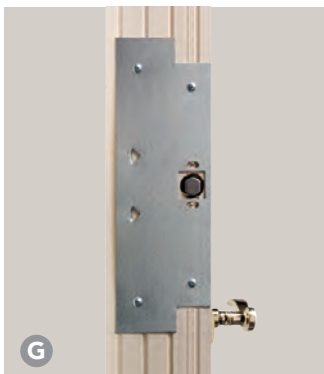

We include our **20-gauge security plate** for extra strength and to help prevent kick-ins.

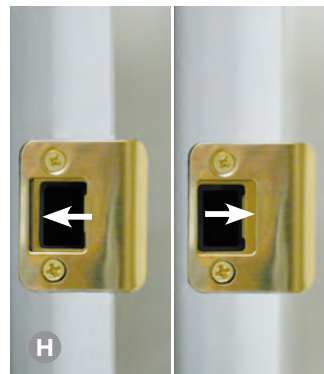

We include a **solid brass fully adjustable strike plate** of our own exclusive design. This unique 2-piece construction makes our doors easier to custom fit.



The **dust box** in the deadbolt strike provides a barrier to air infiltration while providing a nice appearance that most other door manufacturers don't provide.

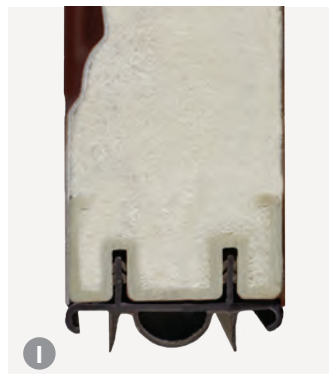

Bulb and dual blade sweep virtually eliminates drafts, keeping your home comfortable.

THE COMPONENTS



FRAMES

FrameSaver®

Real World Frame Issues



Shrinking and swelling occur from changes in relative humidity in the atmosphere. **Water** wicks up through wood fibers resulting in **paint peeling, rot and mold**. Traditional door frames begin to rot within 3-6 months of field installation.

FrameSaver Advantages

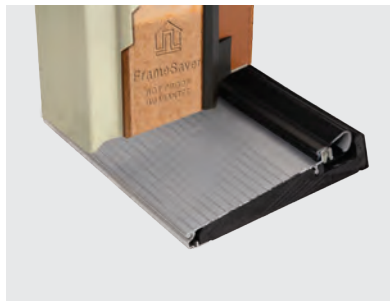

Our **finger-jointed composite bottom** never absorbs water, warps, cracks or rots, and paints and finishes just like wood. Plus, FrameSaver is backed by the industry's only **fully-transferable lifetime limited warranty** for ultimate peace of mind.

FusionFrame™

FusionFrame: A one-of-a-kind alternative to composite or wood jambs, this Endura® component utilizes the strength of an LVL interior, the rot-proof performance of a FrameSaver® bottom, and the durability of a composite frame exterior. Offering a lifetime jamb warranty*.

PREFINISHED, MAINTENANCE-FREE

Available as a textured or smooth frame, providing you with the benefit of a prefinished, maintenance-free system, along with the beauty of a stain or paint finish that matches your entry door.

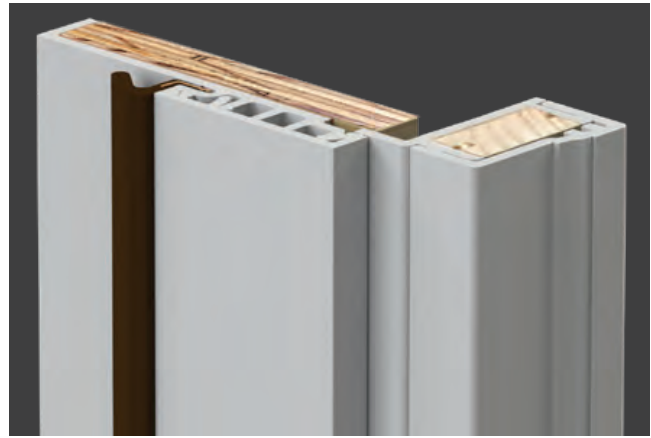

Not available for transoms or outswing doors. See Price List for complete limitations and restrictions

*Finish warranty will match the finish warranty of door series

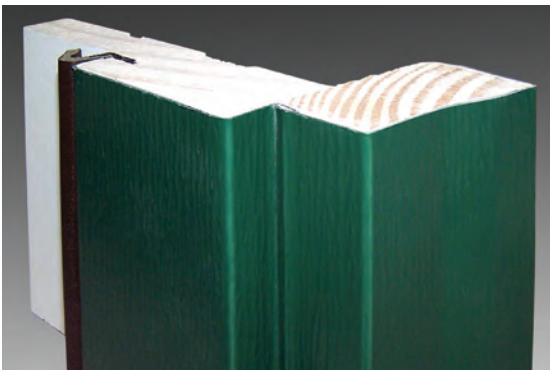

FrameSaver wood frame and brickmold with finger-jointed composite bottom prevents water absorption and carries a Lifetime Limited Warranty when used with **PVC vinyl coated aluminum frame cladding** outside. **Also available with smooth cladding.**

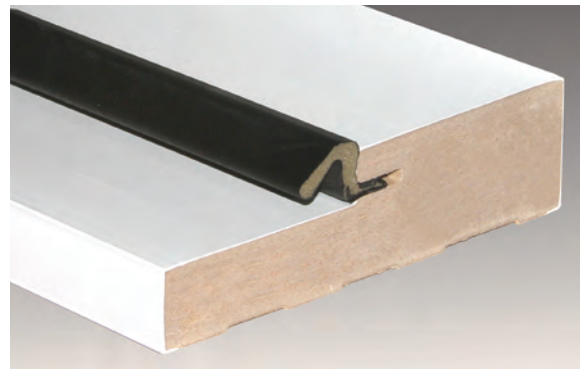

Our **PermaTech™ Composite door frame system** option combines all the strength and convenience of wood with enhanced properties that make it moisture and insect resistant. PermaTech will not absorb or wick moisture and will never rot or splinter, and is covered by a Lifetime Limited Warranty.*

* No storm door applied. See full warranty for limitations

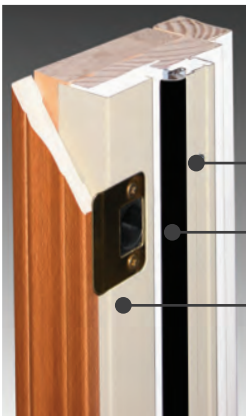

Steel L-Frame

Available on select Signet and Legacy door styles

● Aluminum door stop provides greater security and is more durable than wood.

● Energy efficient weatherstripping.

● 18-gauge steel L-frame with a 12-gauge hinge plate welded on for extra strength and security.

(NOT tested for Certified Wind Load or Impact Shield regions)

Not all Steel L-Frames are ENERGY STAR® certified. Visit provia.com website for manufacturer's certification statement.

EMBARQ® FIBERGLASS

EMBARQ SKIN OPTIONS



A NEW WAY OF THINKING

We set out on a journey to develop a new door and it expanded into a complete philosophy of creating unrivaled efficiency in home building products. We call this new way of thinking "enVision," and are proud to introduce its first creation: **Embarq** – the doorway to innovation and efficiency.

15-YEAR FINISH WARRANTY*

See pgs. 102-109 for paint and stain finishes



ALL Embarq Fiberglass Entry Systems are ENERGY STAR® Certified.

EMBARQ FIBERGLASS DOOR STYLES

See pages 36-90 for glass availability.

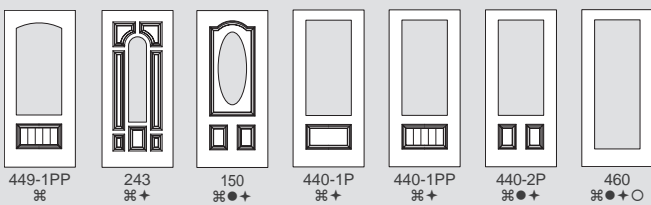
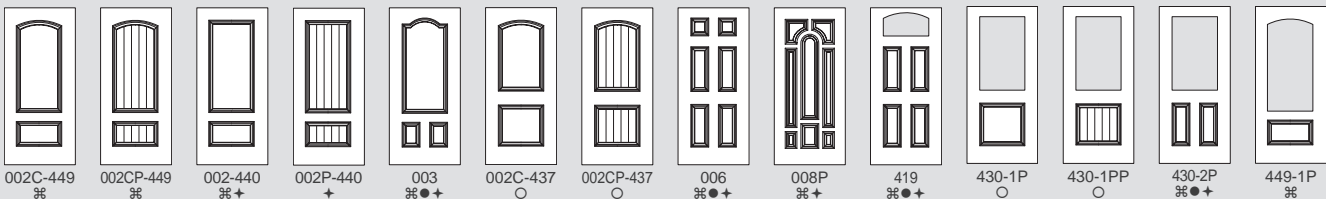

SIDELITES

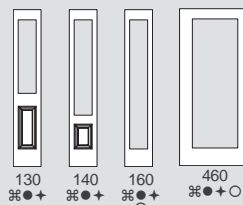

- ⌘ Embarq® Cherry
- Embarq® Mahogany
- + Embarq® Oak
- Embarq® Knotty Alder

*Warranty time period may be limited in extreme applications. See warranty for details.

Stiles and rails are dovetailed and glued at each corner creating a structurally solid, integrated frame.



To enhance efficiency and accommodate more insulation, we thickened the door and sidelites from the standard 1¾" to 2½" which is **43% thicker** than standard exterior doors. We also engineered a **dual perimeter seal** for the entry door to create a superior barrier against drafts and energy leaks.



We engineered a channel in the side rails and header of the door to allow for a **larger energy efficient polyurethane core**. Our computer-controlled process fills every crevice with the foam barrier material resulting in **a level of energy efficiency unparalleled in the industry**.

We started from the inside out to maximize energy savings and reduce thermal loss, resulting in the most energy efficient door in the U.S. market. In fact, this door offers at least **4-times more insulating value than a typical wood door** giving an unprecedented U-Factor of 0.09 - the lowest recorded heat conduction measurement for entry doors in the U.S.

Door edge is constructed with cherry, mahogany or oak wood matching the selected series.

The **4¼" finger-jointed 4-ply hardwood strike stile** provides a solid mounting surface for Emtek® hardware and superior structural integrity.

The **authentic wood look** is made possible by using cutting-edge **NVD** (Nickel Vapor Deposition) technology by MasterGrain™.

Scientifically formulated compounds provide superior resistance to denting, splitting, cracking and warping.

The revolutionary **DuraFuse™ Finishing System** featuring **P³ Fusion** yields unprecedented finish durability.

Z-AC Threshold with **auto-adjusting riser**. Standard with anodized bronze finish.



We **custom-designed a sweep** to accommodate the Embarq door's added thickness. This creates a new breed of thermal barrier to keep out unwanted elements and uncomfortable temperatures.



QUAD GLASS SYSTEM

Our enVision™ innovation and technology has created a revolutionary new design utilizing a Quad Glass System. This glass system is only available for Embarq fiberglass doors and sidelites and utilizes the most energy efficient glass package available on the market today. This high performance glass system provides an optimal energy efficiency rating.

- A** Low-E Glass Surface
- B** Krypton Filled Air Space
- C** Decorative Glass Core
- D** Super Spacer®
- E** Tri-Seal Spacer
- F** We re-engineered our ComforTech Warm Edge Glazing System to accommodate for the extra panes of glass in this highly efficient package.

EMBARQ GLASS PACKAGES

ComforTech™ **QLK**
(Krypton Gas Filled)



R-Value of 10

ComforTech™ **QLA**
(Argon Gas Filled)



R-Value of 9

R-Value reflects properties of the glass only.
Embarq glass package center of glass calculations.



SKINS AND FINISHES

Embarq doors available in Cherry, Mahogany, Oak and Knotty Alder and feature all the same stain and paint finishes as our Signet® doors shown on pgs. 102-109.

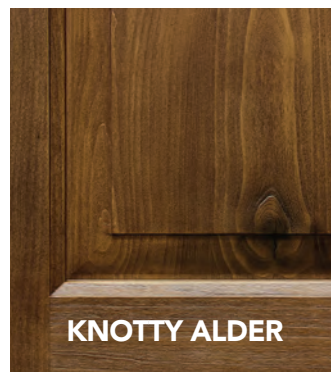

HARDWARE

Embarq doors are only available with Emtek® hardware. See pg. 116 for finish availability.

EXTERIOR STYLES



Melrose Imperial Ribbon & Reed Orleans Marietta

INTERIOR STYLES (Any interior handle can be used with any exterior handle)



Egg (Shown on Melrose) Egg (Shown on Marietta) Cortina (Shown on Orleans) Turino (Shown on Imperial and Ribbon & Reed)



Satin Nickel casing with Bronze hardware

Embarq doors are also available with Colonial Door Knocker, Peepsite, Kick Plate (on page 127), Faux Speakeasy, Hinge Straps and Clavos (on page 128).

SIGNET® FIBERGLASS

SIGNET SKIN OPTIONS



Signet Fiberglass doors are available in Cherry, Mahogany, Oak, Fir, Knotty Alder and Smooth Series. Structurally, the Signet door is far superior to traditional fiberglass doors with robust hardwood stiles and rails dovetailed at each corner. All Signet Fiberglass doors exhibit our exclusive DuraFuse™ Finishing System featuring P³ Fusion, allowing us to offer an industry-best 10-year* finish warranty.



Most Signet Fiberglass Entry Systems are ENERGY STAR® Certified.

15-YEAR FINISH WARRANTY*
See pgs. 102-109 for paint and stain finishes



CUSTOMIZE BOTH SIDES

You can customize your entry by ordering a different series, style and finish on each side of your door.



Patented†



CUSTOM WIDTHS & HEIGHTS

Need a little more height or a little less width? We offer customized door and sidelite widths and heights in 1/8" increments.

SIGNET FIBERGLASS DOOR STYLES See pages 36-90 for glass availability.

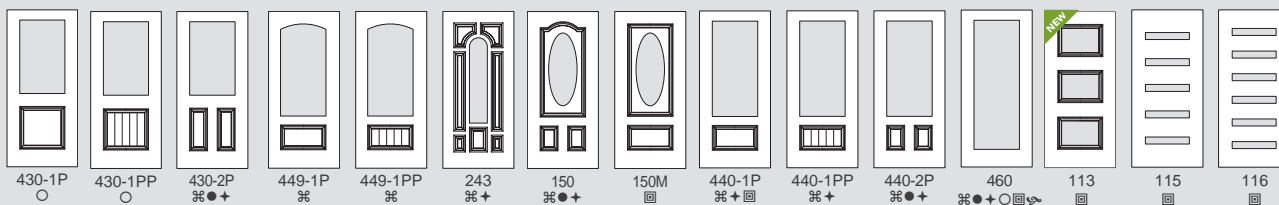
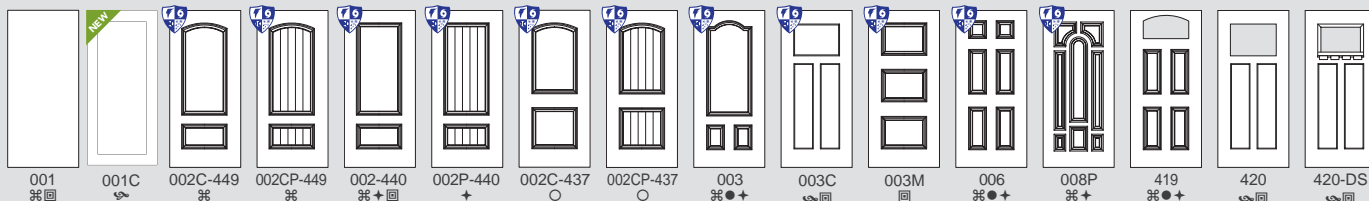

SIDELITES

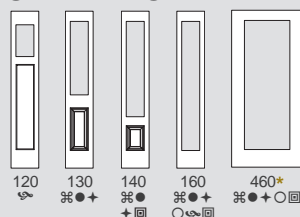

- ⌘ Signet Cherry
- Signet Mahogany
- + Signet Oak
- Signet Knotty Alder
- ⌘ Signet Fir
- ⊞ Signet Smooth

Signet Fiberglass doors without glass are available as an Impact Shield Product.

* NOT tested for Certified Wind Load regions

Plugless Trim not available on Signet Fir 460

Entry System U-Factor: As low as .16 (Tested to NFRC specifications for a 6 panel door with wood frame).

Note: All Signet doors are shipped finished.

* Warranty time period may be limited in extreme applications. See warranty for details.
† Patents - USD617005, USD621062, USD621063, USD625837, USD625024

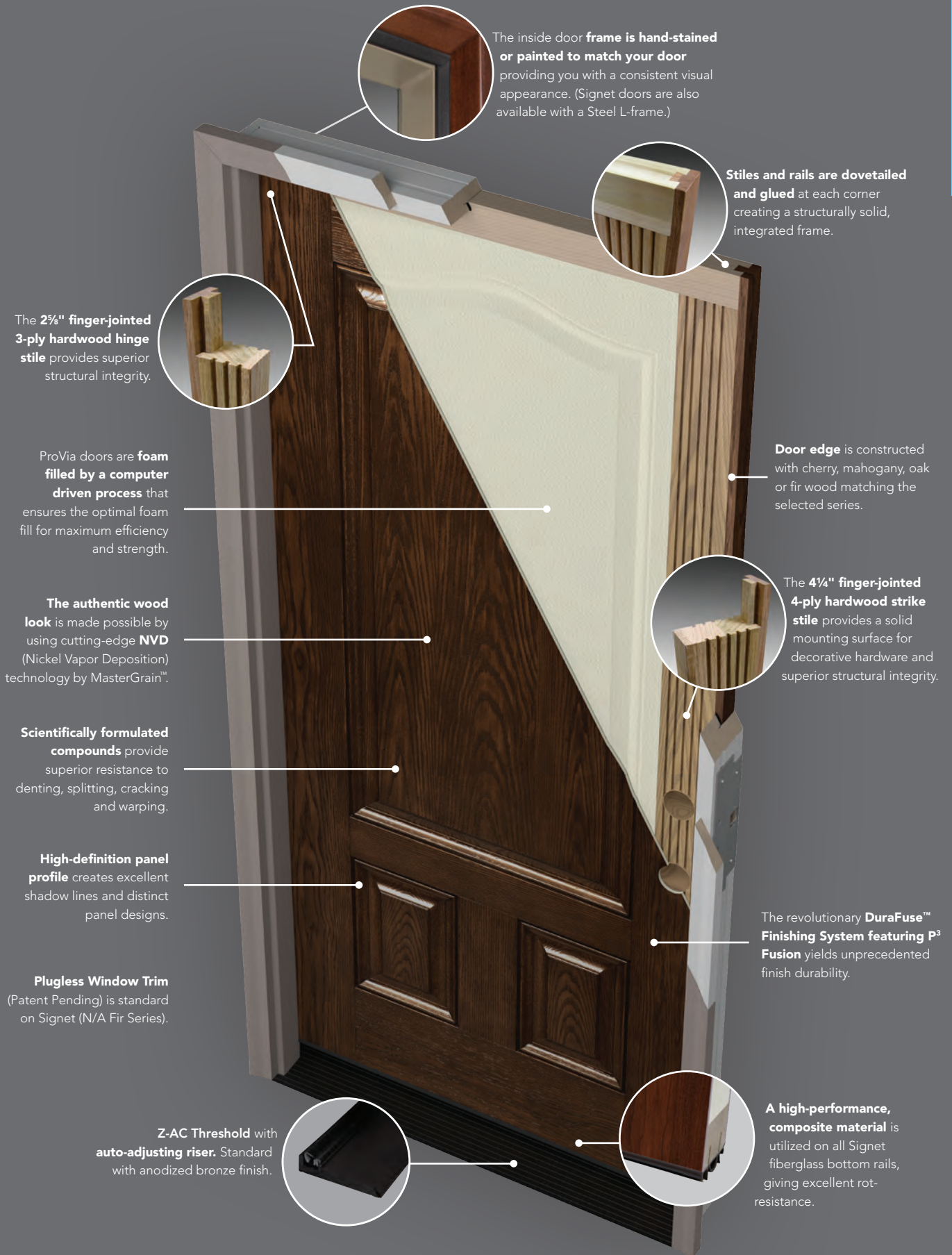

The inside door **frame is hand-stained or painted to match your door** providing you with a consistent visual appearance. (Signet doors are also available with a Steel L-frame.)

Stiles and rails are dovetailed and glued at each corner creating a structurally solid, integrated frame.

The **2 1/2" finger-jointed 3-ply hardwood hinge stile** provides superior structural integrity.

ProVia doors are **foam filled by a computer driven process** that ensures the optimal foam fill for maximum efficiency and strength.

Door edge is constructed with cherry, mahogany, oak or fir wood matching the selected series.

The **authentic wood look** is made possible by using cutting-edge **NVD** (Nickel Vapor Deposition) technology by MasterGrain™.

The **4 1/4" finger-jointed 4-ply hardwood strike stile** provides a solid mounting surface for decorative hardware and superior structural integrity.

Scientifically formulated compounds provide superior resistance to denting, splitting, cracking and warping.

High-definition panel profile creates excellent shadow lines and distinct panel designs.

The revolutionary **DuraFuse™ Finishing System** featuring **P³ Fusion** yields unprecedented finish durability.

Plugless Window Trim (Patent Pending) is standard on Signet (N/A Fir Series).

Z-AC Threshold with auto-adjusting riser. Standard with anodized bronze finish.

A **high-performance, composite material** is utilized on all Signet fiberglass bottom rails, giving excellent rot-resistance.

HERITAGE™ FIBERGLASS

HERITAGE SKIN OPTIONS



Heritage Fiberglass doors feature enhanced woodgrain texture, improved definition embossing and a hardwood edge to prevent warping.



Most Heritage Fiberglass Entry Systems are ENERGY STAR® Certified.

10-YEAR FINISH WARRANTY*

See pgs. 102-109 for paint and stain finishes



CUSTOM HEIGHTS

Need a little more or a little less height? We offer customized door and sidelite heights in 1/8" increments.

HERITAGE FIBERGLASS DOOR STYLES

See pages 36-90 for glass availability.

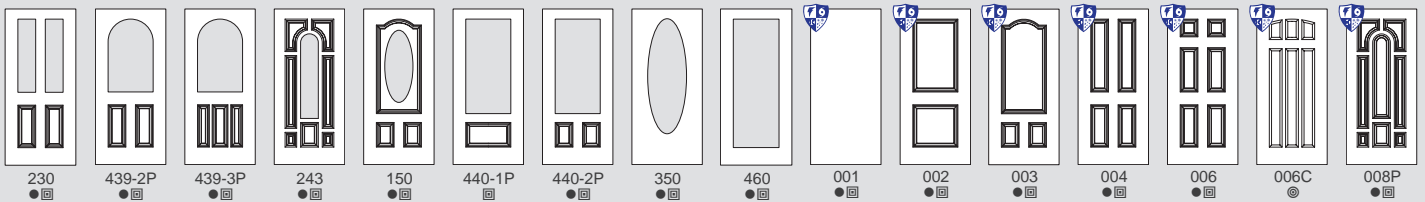
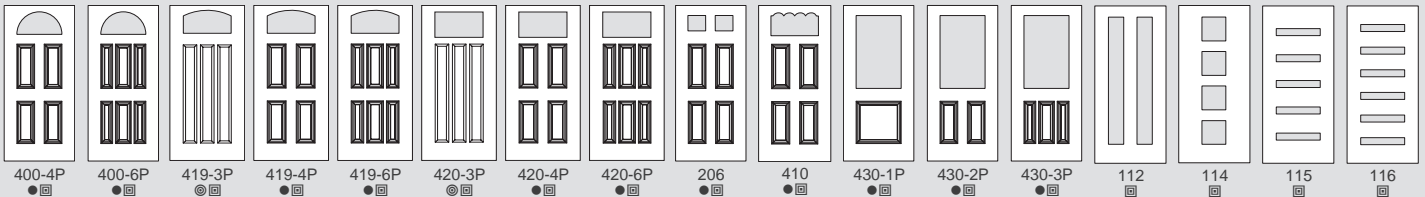

SIDELITES

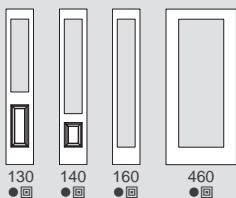

- Oak Grain
- ◎ Hemlock Grain
- ▣ Smooth Fiberglass

All Heritage Fiberglass doors without glass are available as an Impact Shield Product.

Entry System U-Factor: As low as .14
(Tested to NFRC specifications for a 6 panel door with wood frame).
* Warranty time period may be limited in extreme applications. See warranty for details.



Polyurethane core reduces energy loss.

Improved definition panel profile creates excellent shadow lines and distinct panel designs.

Specially engineered fiberglass door facings will not dent and resist splitting, cracking and warping.

Plugless Window Trim is optional on Heritage Fiberglass (see Price List for available styles)

ZAI™ threshold has a manually-adjustable riser with complementary screw cover caps. Standard with aluminum mill finish.

1 1/4" Finger-jointed, 2-ply solid oak laminated stiles for both hinge and strike sides are proven to provide increased rigidity and structural integrity.

Variable-depth woodgrain texture with hand-applied stain imitates a wood door appearance.

Square-edge design offers an attractive wood door appearance.

Lock area is reinforced to provide a solid mounting surface for decorative hardware.

A high-performance, composite material is utilized on all Heritage fiberglass bottom rails, giving excellent rot-resistance.

LEGACY™ STEEL

LEGACY SKIN OPTIONS



Legacy Steel features add up to a professional-class product. Whether you select Legacy Woodgrain Textured Steel or Smooth Steel, our entry systems will provide an elegant, durable and energy efficient addition to any home.

10-YEAR FINISH WARRANTY*
See pgs. 102-109 for paint and stain finishes



Most Legacy Steel Entry Systems are ENERGY STAR® Certified.

Legacy Steel Doors with full-lite or half-lite decorative glass with ComforTech™ glazing will include a pane of Low-E glass in order to be ENERGY STAR certified. This includes the following styles; 150, 230, 239, 240, 350, 430, 437, 439 and 460. Since Low-E glass has a slight color tint, it is recommended that sidelites and transoms are ordered with optional Low-E pane to match the door.



CUSTOMIZE BOTH SIDES
You can customize your entry by ordering a different series, style and finish on each side of your door.



CUSTOM WIDTHS & HEIGHTS
Need a little more height or a little less width? We offer customized door and sidelite widths and heights in 1/8" increments.

LEGACY STEEL DOOR STYLES See pages 36-90 for glass availability.

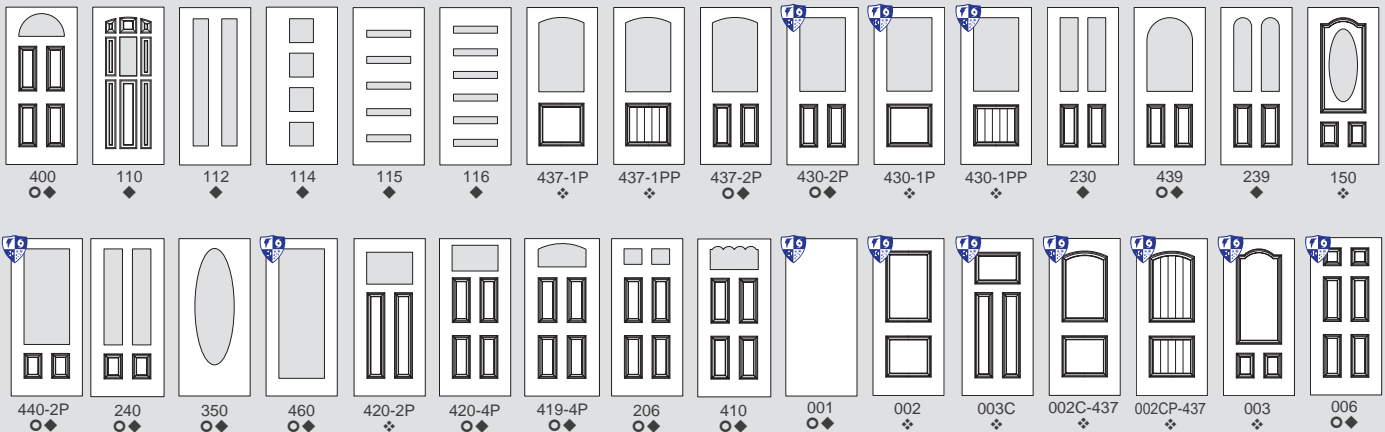

SIDELITES

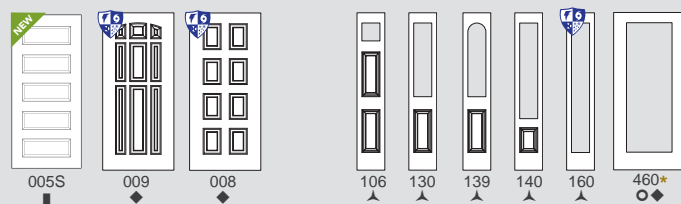

- 20-gauge Woodgrain Textured Steel
- ◆ 20-gauge Smooth Steel
- ◇ 20-gauge Smooth Steel with High-Definition Embossing
- ▲ 24-gauge Smooth or Textured Steel (used with all 20-gauge doors)
- 20-gauge smooth shaker

† Indicated Legacy Steel doors are available as an Impact Shield Product.

* NOT tested for Certified Wind Load regions

Entry System U-Factor: As low as .17 (Tested to NFRC specifications for a 6 panel door with wood frame).

* Warranty time period may be limited in extreme applications. See warranty for details.

† Patent - USD621062



Composite top endcaps increase rigidity and energy efficiency.



Special adhesives/thermal barrier reduce heat and cold transfer, while our exclusive tab and slot system of **mechanical interlocks** gives the door exceptional structural strength.

ProVia doors are **foam filled by a computer driven process** that ensures the optimal foam fill for maximum energy efficiency and strength.

The edges and face skin of our steel doors are **one continuous piece of steel** for strength and durability.

To reinforce the lock and deadbolt area, we add a **rigid composite lock block** to all of our steel doors.

Plugless Window Trim is optional on Legacy Steel (see Price List for available styles)

Our 20-gauge steel doors give you **49% more galvanized steel** than a standard 24-gauge door.



Composite bottom endcaps increase rigidity and energy efficiency.

Z-AC Threshold with auto-adjusting riser. Standard with aluminum mill finish.

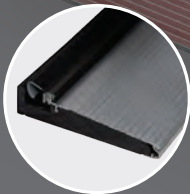

8' DOORS

8' Doors provide a majestic first impression. Choose from many available glass and door styles (shown on pgs. 36-90). Trilennium® multi-point hardware offers homeowners better door closure and sealing than a single point lock.

Trilennium or Hoppe multi-point hardware is required on all 8' fiberglass doors. See pages 112-114 for more information on Trilennium and Hoppe hardware.

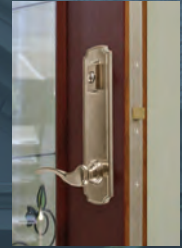

440BRC, 140BRC

SIGNET FIBERGLASS DOOR STYLES

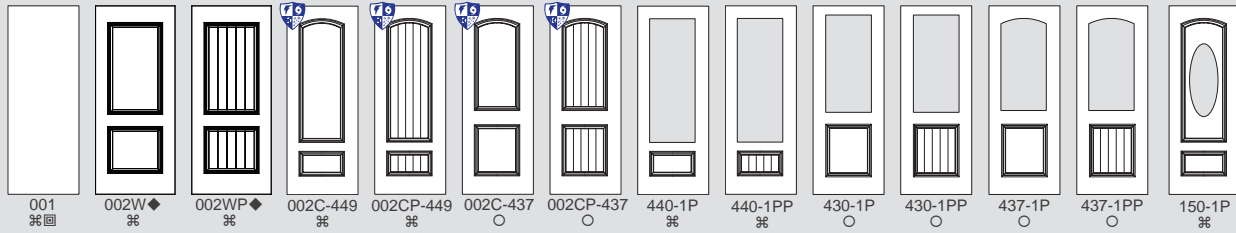

SIDELITES

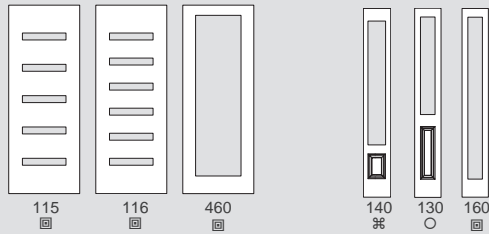

- ☞ Signet Cherry
- Signet Mahogany
- + Signet Oak
- Signet Knotty Alder
- ☞ Signet Fir
- ☒ Signet Smooth
- ◆ Only available in 42" x 96" size

Entry System U-Factor: As low as .16 (Tested to NFRC specifications for a 6 panel door with wood frame).
 Note: All Signet doors are shipped finished.

* Warranty time period may be limited in extreme applications. See warranty for details.
 † Patents - USD617005, USD621062, USD621063, USD625837, USD625024

HERITAGE FIBERGLASS DOOR STYLES

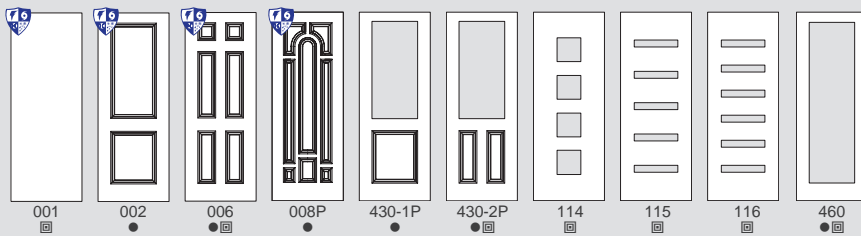

- Oak Grain
- ◎ Hemlock Grain
- ☒ Smooth Fiberglass

Entry System U-Factor: As low as .14 (Tested to NFRC specifications for a 6 panel door with wood frame).
 * Warranty time period may be limited in extreme applications. See warranty for details.

SIDELITES

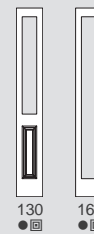

LEGACY STEEL DOOR STYLES

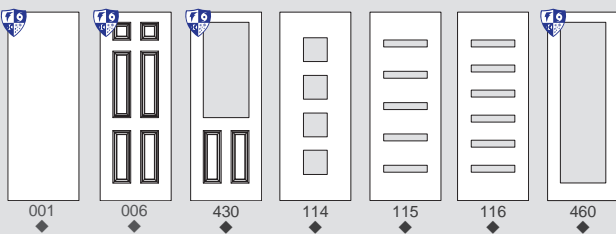

- 20-gauge Woodgrain Textured Steel
- ◆ 20-gauge Smooth Steel
- ❖ 20-gauge Smooth Steel with High-Definition Embossing
- ▲ 24-gauge Smooth or Textured Steel (used with all 20-gauge doors)

Entry System U-Factor: As low as .17 (Tested to NFRC specifications for a 6 panel door with wood frame).
 * Warranty time period may be limited in extreme applications. See warranty for details.
 † Patent - USD621062

SIDELITES



☒ Indicated doors are available as an Impact Shield Product.

* NOT tested for Certified Wind Load regions

FRENCH DOORS

French doors make an elegant statement like nothing else. Express your personality by creating a simple yet striking entry. Make it as ornate and beautiful as you like.



420DC-SD6-DS Pecan Finish

FRENCH DOOR DETAILS

- All door styles are available as a French Door
- Available with FrameSaver® or Steel L-Frame
- Hinged on each end with door knobs in the center
- Available with either left or right active door (main entryway)
- Center astragal is attached to the inactive door and includes top and bottom slide bolts (used to open inactive door)
- Available as inswing or outswing
- Header security plate standard on Frame
- Hardware Installation: locksets, deadbolts and kickplates will be installed on active and inactive doors, all other hardware on active door only
- Also available with Trilennium hardware

ASTRAGAL DETAILS The French Door Astragal provides functionality and security



Astragal secures inactive door at top and bottom of your french door system



Lockable throw bolts improve security



Astragal bolt penetrates threshold allowing boot to seal, creating a better barrier against the elements



Astragal is stained to match Signet Fiberglass stained doors.

STYLES/CONFIGURATIONS All door styles are available as a French Door.

Custom size clear glass transom ☼ pg. 90

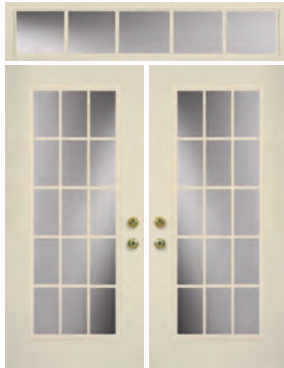

460DC-IGT 460DC-IGT

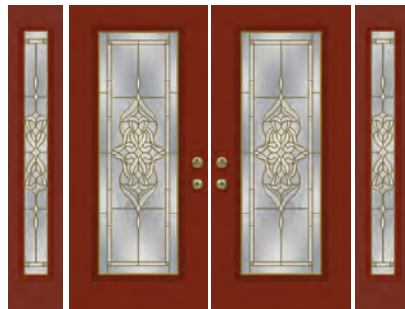

160SYA 460SYA 460SYA 160SYA



460LAU 460LAU

☼ Cannot be mulled with Heritage Fiberglass doors in Certified Wind Load regions



UNEQUAL FRENCH DOORS

You now have the ability to utilize the larger entry door day-to-day, yet have the option to open the smaller, inactive door to gain full access.

Available in smooth steel only. Internal blind sizes are limited. See Price List for details.

345

INSCRIBED DOORS

Elegant and refined to complement an entrance way. Each design is engraved into a Signet® Cherry fiberglass panel showcasing true richness of color and sophistication. Also available with three stainless steel inlay models.

INSCRIBED STYLES (Only available in flush Signet cherry doors.)



STAINLESS STEEL INLAY STYLES (Only available in flush Signet cherry doors.)

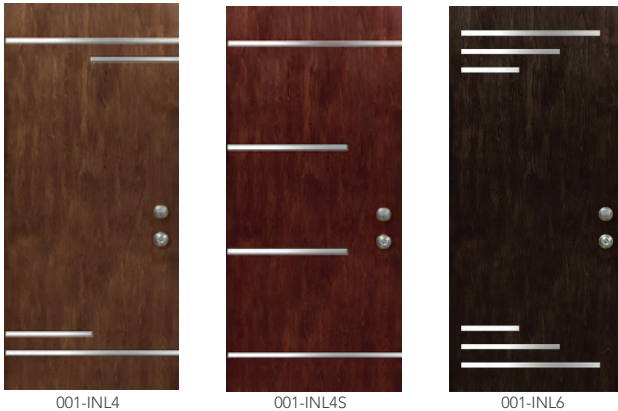

AVAILABLE COLORS

CHERRY STAINS

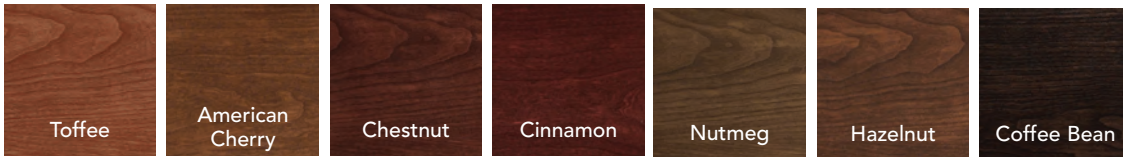

15-YEAR FINISH WARRANTY*

Embarq and Signet Fiberglass

*Warranty time period may be limited in extreme exposure applications. See warranty for details.



DOORS WITHOUT GLASS

Doors Without Glass will fill your needs beautifully when privacy is needed.

LIFETIME LIMITED WARRANTY
Includes Glass Breakage & Seal Failure

DOORS WITHOUT GLASS STYLE AVAILABILITY

	Doors													8' Doors										
	009	008P	008	006C	006	004	005	003M	003	003C	002C(P)-449	002	002C(P)-437	002-440	002P-440	001	001	002W(P)	002C(P)-449	002C(P)-437	002	006	008P	
Embarq / Signet Mahogany Series					•				•															
Embarq / Signet Cherry Series	•				•							•					*	Δ*	*					
Embarq / Signet Oak Series	•				•									•	•									
Signet Fir Series										•						•								
Embarq / Signet Knotty Alder Series																								*
Signet Smooth Series								•						•		•								
Heritage Woodgrain Textured Fiberglass	•		•	•	•				•			•										•	•	•
Heritage Smooth Fiberglass	•				•	•			•			•												•
20-Gauge Woodgrain Textured Steel					•																			•
20-Gauge Smooth Steel	•	•	•	•	•	•			•	•		•	•			•								•

Δ Not tested for Certified Wind Load region
* Embarq doors and sidelites are not available in 8' heights



All Entry Systems Without Glass are ENERGY STAR® Certified.



009



008P

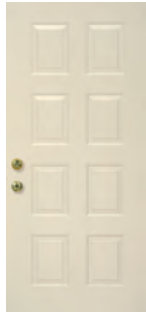

008



006C



006



004

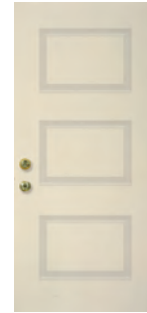

003M



003

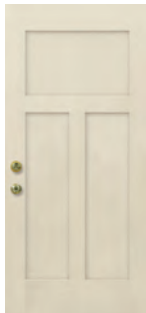

003C

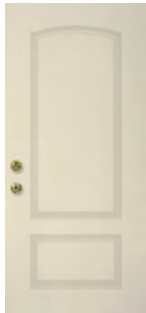

002C-449

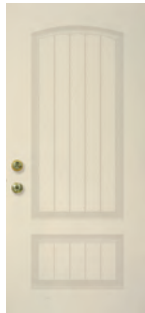

002CP-449



002



002C-437



002CP-437



002-440



002P-440



001



001

002W◆

002WP◆



002C-449



002CP-449

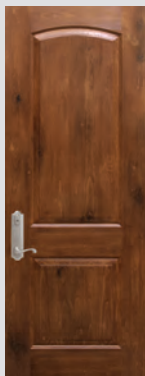

002C-437

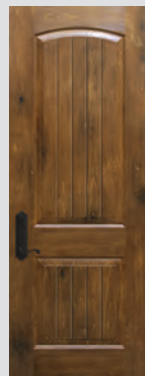

002CP-437

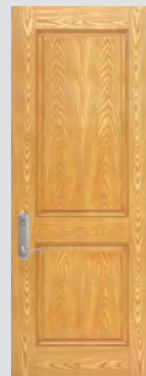

002



006



008P

◆ Only available in 42" x 96" size

COMFORTECH™

LIFETIME LIMITED WARRANTY
Includes Glass Breakage and Seal Failure

Measurably improve thermal performance with our ComforTech™ Warm Edge Glazing System. You'll enjoy better energy efficiency and a warmer glass edge.

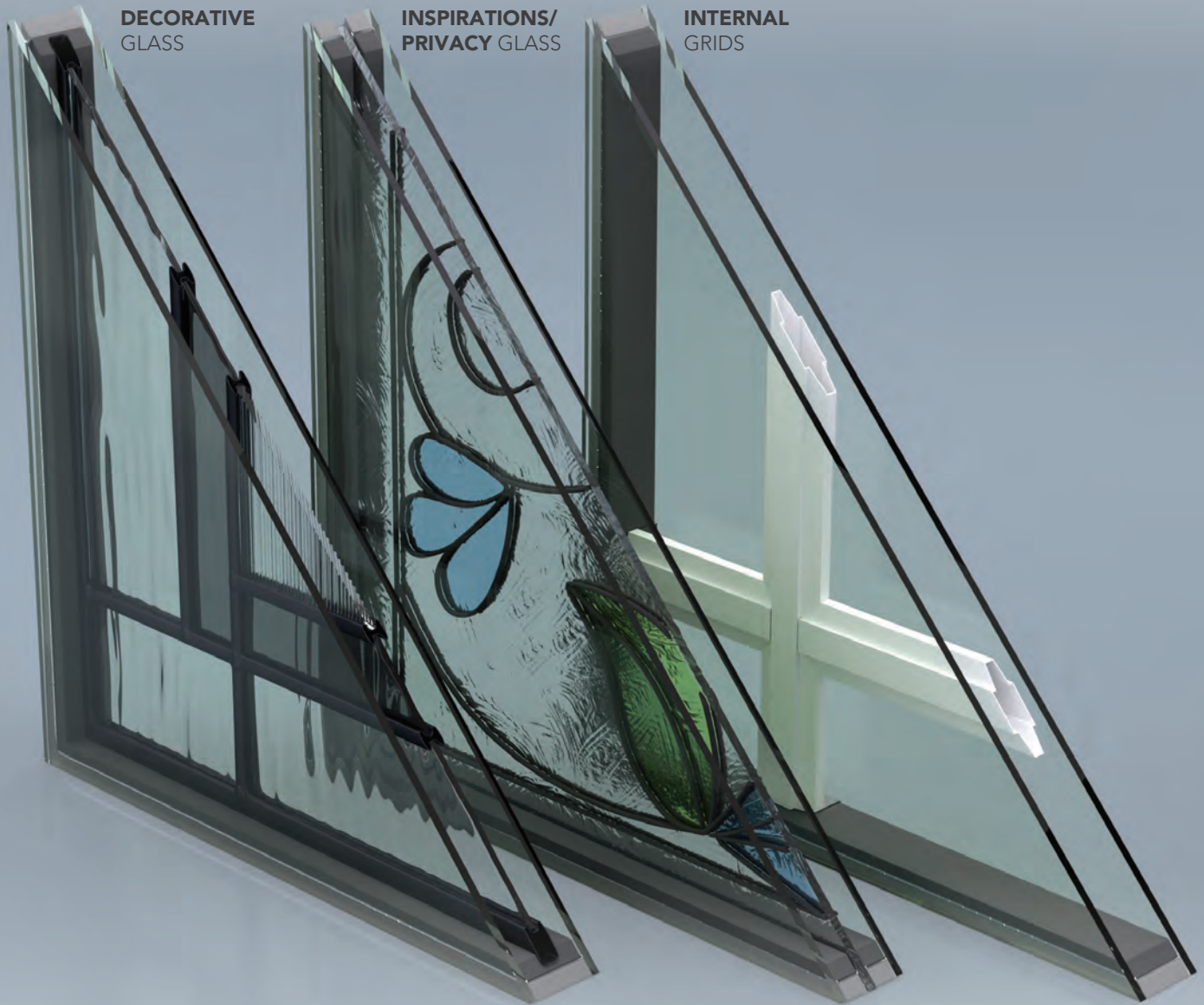

COMFORTECH WARM EDGE GLAZING SYSTEM IS INCLUDED IN ALL:

- Decorative Glass
- Inspirations™ Art Glass
- Privacy Glass (Except for Dialogue Layered Glass™)
- Clear Glass
- Grids (Internal, External and SDL)
- Hinged Patio Doors
- Vinyl Sliding Patio Doors
- Vinyl Windows



COMFORTECH ADVANTAGES

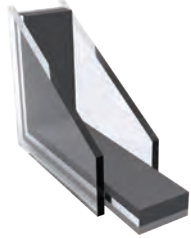

The NO-Metal Advantage

"Thermal efficiency through no presence of conductive metals" is the Super Spacer hallmark.

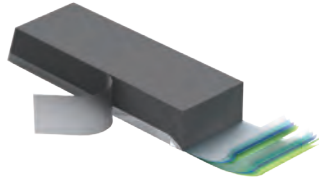

Mylar 10-Layer Vapor Barrier

The Super Spacer thermoset foam matrix is exceptional. Moisture is kept out, gas is kept in and conductivity is virtually nonexistent.

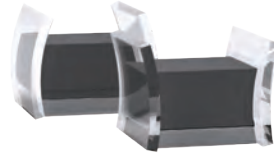

Withstands Normal Bowing

The design of our Warm Edge Glazing System stands up to the bending and bowing that is natural in any glass unit.



Enhanced Noise Reduction

Our all-foam formula's excellent sound-dampening properties reduce outside noise, even in industrial environments.

GLAZING SYSTEM OPTIONS See page 150 for Impact Shield laminated glass options

ComforTech™ TLK ComforTech™ TLK-UV



R-Value reflects properties of the glass only.
Center of glass calculations are based upon software from Lawrence Berkeley National Laboratory.

ComforTech™ TLA ComforTech™ TLA-UV



ComforTech™ DLA ComforTech™ DLA-UV

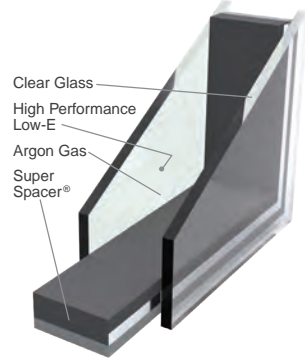

ComforTech™ DC

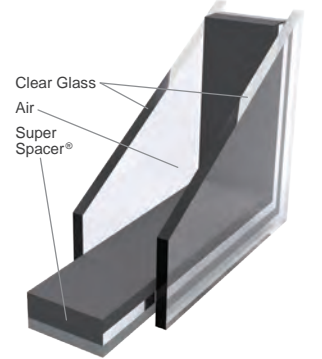

COMFORTECH™ ELEVATION SERIES

for customers in high altitude areas

Insulated glass without Argon or Krypton. Capillary tubes are open and inserted behind glazing bead. Low-E softcoat and hardcoat available for vinyl windows and vinyl patio doors.

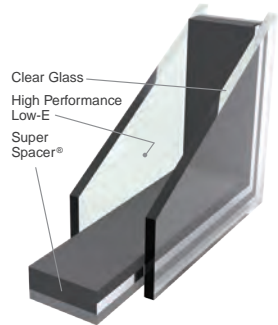
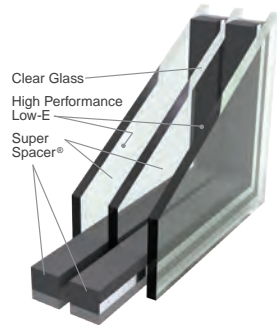

Understanding the Acronyms

- T - Triple Glazed
- D - Double Glazed
- L - Low E
- C - Clear
- A - Argon
- K - Krypton
- E - Elevation (no gas)
- UV - Ultraviolet
- HC - Hard Coat

Some Elevation Series (TLE-UV, TLE, DLE-UV and DLE) glass offerings require a hardcoat option to be ENERGY STAR® compliant.

DECORATIVE GLASS



Highly-skilled craftsmen assemble hand-beveled glass accented with a variety of unique glass options by precisely cutting, mitering and soldering each component into artistically designed patterns.

Decorative glass purposefully seeks visual character through aesthetic imperfections, while maintaining structural stability. These "imperfections" mimic the hand-made sheet glass of centuries past. They come in the form of textural waves and striations, random seeds (air bubbles) and a variety of other natural effects.

Decorative glass achieves its personality through these apparent flaws and no two sheets are ever identical. Each glass panel is hand-made and reflects minor differences from piece to piece. This is characteristic of any hand-made product and adds to the charm and beauty of the product.

We continually inspect for consistency. The patterns can vary in size and particular shapes, but pose no danger of spontaneous breakage or structural instability. Any patterns that are severely out of character with the glass are not accepted. Our goal is to provide the finest quality glass panels.

ALL* DECORATIVE GLASS:

1. ProVia Exclusive

These decorative glass designs are only found on ProVia doors. This gives your entryway a unique style that can't be found anywhere else.

2. Includes our ComforTech™ Warm Edge Glazing System

Measurably improve thermal performance with our ComforTech Warm Edge Glazing System. You'll enjoy better energy efficiency and a warmer glass edge.

3. Impact Shield available

Impact Shield Products are designed to protect your family and home against the harshest storms and help deter burglaries. Impact Shield products feature laminated glass and can withstand repeated blows from wind-borne debris or unwanted intruders. See page 160 for style availability.

4. Covered by a Lifetime Limited Warranty

Warranty includes glass breakage and seal failure.

*Does NOT include Dialogue Layered Glass™



Each piece of glass is meticulously inspected for consistency.

NEW

MIRAGE

DECORATIVE GLASS

Mirage offers effortless style, with narrow/thin reed glass all over, complemented by clear beveled glass. Zinc coming tops it off, making it a simple, modern and attractive design.

CAMING FINISH

Zinc

PRIVACY RATING

1 2 3 4 5 6 **7** 8 9 10

less privacy

more privacy

Clear Beveled

Caming

Narrow/Thin Reed

LIFETIME LIMITED WARRANTY

Includes Glass Breakage & Seal Failure





All Full Wood Frame and Composite Frame Entry Systems using Laurence Glass are ENERGY STAR® Certified and some Steel L-Frame Entry Systems using Laurence Glass are ENERGY STAR Certified. See the ENERGY STAR section of our website for energy ratings on specific styles.

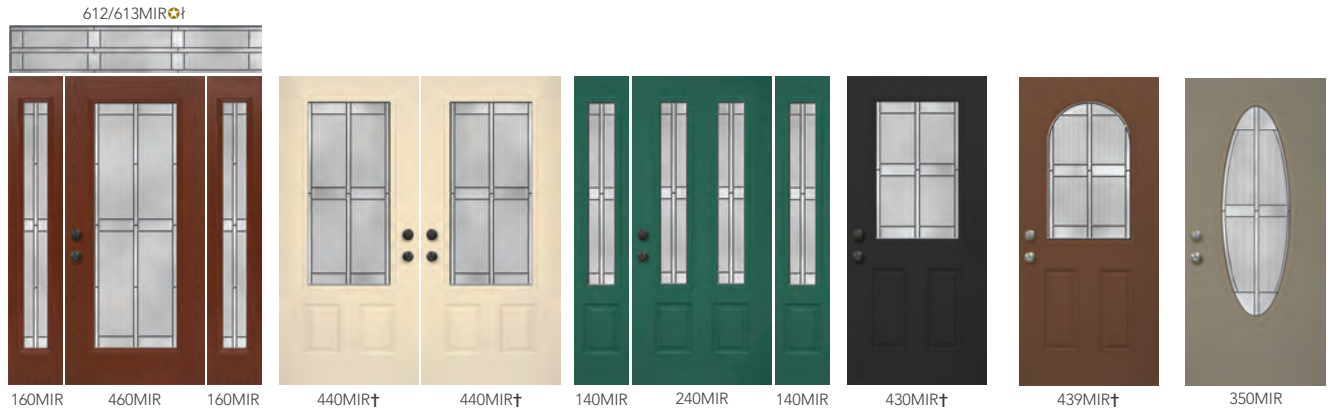

MIRAGE STYLE AVAILABILITY

	Doors											Sidelites					8' Doors				8' Sidelites				
	460	440	449	350	150	240	430	439	230	239	420	419	160	140	770	130	139	120	440	430	437	150	140	130	
Embarq / Signet Mahogany Fiberglass	•	•			•		•				•		•	•	•	•									
Embarq / Signet Cherry Fiberglass	•	•	•		•		•				•		•	•	•	•				*		*		*	
Embarq / Signet Oak Fiberglass	•	•			•		•				•		•	•	•	•									
Signet Fir Fiberglass	•										•		•					•							
Embarq / Signet Knotty Alder Fiberglass	•						•						•		•					*	*			*	
Signet Smooth Fiberglass	•	•			•						•		•	•	•										
Heritage Woodgrain Textured Fiberglass	•	•		•	•		•	•	•		•		•	•	•	•				•				•	
Heritage Smooth Fiberglass	•	•		•	•		•	•	•		•		•	•	•	•				•				•	
20-Gauge Woodgrain Textured Steel	•	•		•	•		•	•	•		•		○	○	•	○	○								
20-Gauge Smooth Steel	•	•		•	•		•	•	•	•	•		○	○	•	○	○							•	

† For additional door panel styles see pg. 18 (for Embarq®), pg. 22 (for Signet®), pg. 24 (for Heritage™) or pg. 26 (for Legacy™)
 ○ Steel sidelites are made from 24-Gauge steel
 ‡ Requires an additional 6-week lead time
 * Embarq doors and sidelites are not available in 8' heights
 † Cannot be mulled with Heritage Fiberglass doors in Certified Wind Load regions

Mirage Glass

NEW

BROOKHAVEN

DECORATIVE GLASS

Brookhaven is accented with gray antique glass, giving it a subtle hint of color. The hammered glass delivers some privacy and is accentuated with clear beveled and microcubed glass throughout.

CAMING FINISH

Zinc

Patina

Specify caming finish using these codes:
Zinc - BRZ, Patina - BRP

PRIVACY RATING

1 2 3 4 5 6 7 **8** 9 10

less privacy

more privacy

Gray Antique

Clear Beveled

Hammered

Microcubed

Caming

LIFETIME LIMITED WARRANTY

Includes Glass Breakage & Seal Failure





All Full Wood Frame and Composite Frame Entry Systems using Laurence Glass are ENERGY STAR® Certified and some Steel L-Frame Entry Systems using Laurence Glass are ENERGY STAR Certified. See the ENERGY STAR section of our website for energy ratings on specific styles.



Brookhaven Glass

BROOKHAVEN STYLE AVAILABILITY

	Doors												Sidelites					8' Doors				8' Sidelites				
	460	440	449	350	150	240	243	430	439	230	239	420	419	400	160	140	130	139	120	440	430	437	150	140	130	
Embarq / Signet Mahogany Fiberglass	•	•			•			•					•		•	•	•									
Embarq / Signet Cherry Fiberglass	•	•	•		•			•	•				•		•	•	•				*		*		*	
Embarq / Signet Oak Fiberglass	•	•			•			•	•				•		•	•	•									
Signet Fir Fiberglass	•											•			•				•							
Embarq / Signet Knotty Alder Fiberglass	•							•							•						*	*			*	
Signet Smooth Fiberglass	•	•			•							•			•	•										
Heritage Woodgrain Textured Fiberglass	•	•		•	•			•	•	•	•				•	•	•				•				•	
Heritage Smooth Fiberglass	•	•		•	•			•	•	•	•				•	•	•				•				•	
20-Gauge Woodgrain Textured Steel	•	•		•		•		•	•				•	•	○	○	○	○								
20-Gauge Smooth Steel	•	•		•	•	•		•	•	•	•		•	•	○	○	○	○			•				•	

§ Also available in 10" width (which requires an additional 4-week lead time). See Price List for design pattern
 † Requires an additional 6-week lead time
 * Embarq doors and sidelites are not available in 8' heights

† For additional door panel styles see pg. 18 (for Embarq®), pg. 22 (for Signet®), pg. 24 (for Heritage™) or pg. 26 (for Legacy™)
 ○ Steel sidelites are made from 24-Gauge steel
 ✘ Cannot be mulled with Heritage Fiberglass doors in Certified Wind Load regions

NEW

MANHATTAN

DECORATIVE GLASS

Manhattan features streamed glass, clear bevels and gray softwave, combining simplicity and modern style. Accent it with either patina or zinc coming to customize the look.

Streamed

Caming

Clear Beveled

CAMING FINISH

Zinc

Patina

Specify caming finish using these codes:
Zinc - MAZ, Patina - MAP

Gray Softwave

PRIVACY RATING

1 2 3 4 5 6 7 **8** 9 10

less privacy

more privacy

LIFETIME LIMITED WARRANTY

Includes Glass Breakage & Seal Failure





All Full Wood Frame and Composite Frame Entry Systems using Laurence Glass are ENERGY STAR® Certified and some Steel L-Frame Entry Systems using Laurence Glass are ENERGY STAR Certified. See the ENERGY STAR section of our website for energy ratings on specific styles.



MANHATTAN STYLE AVAILABILITY

	Doors						Sidelites				8' Doors		8' Sidelites	
	460	440	240	430	230	420	160	140	130	120	440	430	140	130
Embarq / Signet Mahogany Fiberglass	•	•		•			•	•	•					
Embarq / Signet Cherry Fiberglass	•	•		•			•	•	•		*		*	
Embarq / Signet Oak Fiberglass	•	•		•			•	•	•					
Signet Fir Fiberglass	•					•	•			•				
Signet Smooth Fiberglass	•	•				•	•	•						
Embarq / Signet Knotty Alder Fiberglass	•			•			•					*		*
Heritage Woodgrain Textured Fiberglass	•	•		•	•	•	•	•	•			•		•
Heritage Smooth Fiberglass	•	•		•	•	•	•	•	•			•		•
20-Gauge Woodgrain Textured Steel	•	•	•	•	•	•	○	○	○					
20-Gauge Smooth Steel	•	•	•	•	•	•	○	○	○			•		•

† For additional door panel styles see pg. 18 (for Embarq®), pg. 22 (for Signet®), pg. 24 (for Heritage™) or pg. 26 (for Legacy™)

○ Steel sidelites are made from 24-Gauge steel

‡ Requires an additional 6-week lead time

* Embarq doors and sidelites are not available in 8' heights

⊛ Cannot be mulled with Heritage Fiberglass doors in Certified Wind Load regions

ESSENCE

DECORATIVE GLASS

Essence features a bronze softwave glass combined with micro-granite that brings elegance to a whole new level.

CAMING FINISH

Brass

Zinc

Specify caming finish using these codes:
Brass - ESB, Zinc - ESZ

PRIVACY RATING

1 2 3 4 5 **6** 7 8 9 10

less privacy

more privacy

LIFETIME LIMITED WARRANTY

Includes Glass Breakage & Seal Failure

Caming

Micro-granite

Clear Beveled

Bronze Seedy



440ESB-1PP, 140ESB



All Full Wood Frame and Composite Frame Entry Systems using Essence Glass are ENERGY STAR® Certified and some Steel L-Frame Entry Systems using Essence Glass are ENERGY STAR Certified. See the ENERGY STAR section of our website for energy ratings on specific styles.



ESSENCE STYLE AVAILABILITY

	Doors						Sidelites				8' Doors			8' Sidelites	
	460	440	150	240	430	230	160	140	770	130	440	430	150	140	130
Embarq / Signet Mahogany Fiberglass	•	•	•		•		•	•	•	•					
Embarq / Signet Cherry Fiberglass	•	•	•		•		•	•	•	•	*		*		*
Embarq / Signet Oak Fiberglass	•	•	•		•		•	•	•	•					
Embarq / Signet Knotty Alder Fiberglass	•				•		•		•			*			*
Signet Fir Fiberglass	•														
Signet Smooth Fiberglass	•	•	•				•	•	•						
Heritage Woodgrain Textured Fiberglass	•	•	•		•	•	•	•	•	•		•			•
Heritage Smooth Fiberglass	•	•	•		•	•	•	•	•	•		•			•
20-Gauge Woodgrain Textured Steel	•	•		•	•		○	○	•	○					
20-Gauge Smooth Steel	•	•	•	•	•	•	○	○	•	○		•			•

† For additional door panel styles see pg. 18 (for Embarq®), pg. 22 (for Signet®), pg. 24 (for Heritage™) or pg. 26 (for Legacy™)

§ Also available in 10" width (which requires an additional 4-week lead time). See Price List for design pattern

† Requires an additional 6-week lead time

○ Steel sidelites are made from 24-Gauge steel

* Embarq doors and sidelites are not available in 8' heights

§ Cannot be mulled with Heritage Fiberglass doors in Certified Wind Load regions

CHEYENNE

DECORATIVE GLASS

Cheyenne features micro-granite, hammered and beveled glass that will add elegance to your entryway, while providing a high level of privacy.

CAMING FINISH

Patina

Zinc

Specify caming finish using these codes:
Patina - CHP, Zinc - CHZ

PRIVACY RATING

1 2 3 4 5 6 7 **8** 9 10

less privacy

more privacy

LIFETIME LIMITED WARRANTY

Includes Glass Breakage & Seal Failure



Micro-granite

Clear Beveled

Faceted Jewel

Caming

Hammered

460CHP



All Full Wood Frame and Composite Frame Entry Systems using Cheyenne Glass are ENERGY STAR® Certified and some Steel L-Frame Entry Systems using Cheyenne Glass are ENERGY STAR Certified. See the ENERGY STAR section of our website for energy ratings on specific styles.

512/513CHP †



160CHP 460CHP 160CHP



140CHP 440CHP † 140CHP



350CHP



150CHP †



240CHP



243CHP



130CHP 430CHP †



230CHP



419CHP †



400CHP †



110CHP



8' DOORS

440CHP †

140CHP

430CHZ †

130CHZ

150CHZ

CHEYENNE STYLE AVAILABILITY

	Doors										Sidelites			8' Doors			8' Sidelites			
	460	440	350	150	240	243	430	230	419	400	110	160	140	130	440	430	150	140	130	
Embarq / Signet Mahogany Fiberglass	•	•		•			•		•		•	•	•							
Embarq / Signet Cherry Fiberglass	•	•		•		•	•		•		•	•	•		*		*		*	
Embarq / Signet Oak Fiberglass	•	•		•		•	•		•		•	•	•							
Embarq / Signet Knotty Alder Fiberglass	•						•				•					*				*
Signet Fir Fiberglass	•										•									
Signet Smooth Fiberglass	•	•		•							•	•								
Heritage Woodgrain Textured Fiberglass	•	•	•	•		•	•	•	•	•	•	•	•		•					•
Heritage Smooth Fiberglass	•	•	•	•		•	•	•	•	•	•	•	•		•					•
20-Gauge Woodgrain Textured Steel	•	•	•	•		•	•	•	•	•	○	○	○							
20-Gauge Smooth Steel	•	•	•	•	•	•	•	•	•	•	○	○	○		•					•

† For additional door panel styles see pg. 18 (for Embarq®), pg. 22 (for Signet®), pg. 24 (for Heritage™) or pg. 26 (for Legacy™)

○ Steel sidelites are made from 24-Gauge steel

† Requires an additional 6-week lead time

* Embarq doors and sidelites are not available in 8' heights

⦿ Cannot be mulled with Heritage Fiberglass doors in Certified Wind Load regions

Cheyenne Glass

SYMPHONY

DECORATIVE GLASS

Symphony features a bronze softwave and expresses timeless beauty and elegance at every curve. This design is sure to bring you a pleasing and melodious style.

CAMING FINISH

Brass

Patina

Zinc

Specify caming finish using these codes:
Brass - SYB, Patina - SYP, Zinc - SYZ

PRIVACY RATING

1 2 3 4 **5** 6 7 8 9 10

less privacy

more privacy

LIFETIME LIMITED WARRANTY

Includes Glass Breakage & Seal Failure

Clear Renaissance

Caming

Clear Beveled

Seedy

Bronze Softwave



460SYZ, 160SYZ, 612/613SYZ



All Full Wood Frame and Composite Frame Entry Systems using Symphony Glass are ENERGY STAR® Certified and some Steel L-Frame Entry Systems using Symphony Glass are ENERGY STAR Certified. See the ENERGY STAR section of our website for energy ratings on specific styles.



160SYA 460SYA 160SYA 140SYA 440SYA † 140SYA 160SYA 350SYA 160SYA 770SYA † § † 449SYA † 770SYA † § † 150SYA †



240SYA 243SYA 130SYA 430SYA † 230SYA 120SYA 420SYA-DS 120SYA 419SYA † 400SYA †



460SYA 160SYA 440SYA † 140SYA 430SYA † 130SYA 437SYA † 150SYA

Symphony Glass

SYMPHONY STYLE AVAILABILITY

	Doors										Sidelites				8' Doors					8' Sidelites							
	460	440	350	449	150	240	243	430	230	420	419	400	160	140	770	130	120	460	440	430	437	150	160	140	130		
Embarq / Signet Mahogany Fiberglass	•	•			•			•					•	•	•	•											
Embarq / Signet Cherry Fiberglass	•	•		•	•		•	•			•		•	•	•	•						*				*	
Embarq / Signet Oak Fiberglass	•	•			•		•	•			•		•	•	•	•											
Signet Fir Fiberglass	•									•			•		•		•										
Embarq / Signet Knotty Alder Fiberglass	•							•					•	•	•							*	*				*
Signet Smooth Fiberglass	•	•			•					•			•	•	•								•				•
Heritage Woodgrain Textured Fiberglass	•	•	•		•		•	•	•		•	•	•	•	•							•	•			•	•
Heritage Smooth Fiberglass	•	•	•		•		•	•	•		•	•	•	•	•							•	•			•	•
20-Gauge Woodgrain Textured Steel	•	•	•				•			•	•		○	○	•	○							•	•			•
20-Gauge Smooth Steel	•	•	•		•	•		•	•		•	•	○	○	•	○						•	•			•	•

§ Also available in 10" width (which requires an additional 4-week lead time). See Price List for design pattern
 † Requires an additional 6-week lead time
 * Embarq doors and sidelites are not available in 8' heights

† For additional door panel styles see pg. 18 (for Embarq®), pg. 22 (for Signet®), pg. 24 (for Heritage™) or pg. 26 (for Legacy™)
 ○ Steel sidelites are made from 24-Gauge steel
 * Cannot be mullied with Heritage Fiberglass doors in Certified Wind Load regions
 * In Certified Wind Load region, indicated transoms must be installed in a separate opening or use approved engineering mulls

BERKLEY

DECORATIVE GLASS

Berkley features micro-iced granite, clear bevels, and small hammered with a timeless herringbone pattern that complements modern, contemporary and Arts & Crafts architecture.

CAMING FINISH

Antique Brass

Zinc

Patina

Specify caming finish using these codes:

Antique Brass - BEA, Zinc - BEZ,
Patina - BEP

PRIVACY RATING

1 2 3 4 5 6 **7** 8 9 10

less privacy

more privacy

LIFETIME LIMITED WARRANTY

Includes Glass Breakage & Seal Failure



Clear Beveled

Caming

Small Hammered

Micro-iced Granite

460BEZ, 160BEZ



All Full Wood Frame and Composite Frame Entry Systems using Berkley Glass are ENERGY STAR® Certified and some Steel L-Frame Entry Systems using Berkley Glass are ENERGY STAR Certified. See the ENERGY STAR section of our website for energy ratings on specific styles.

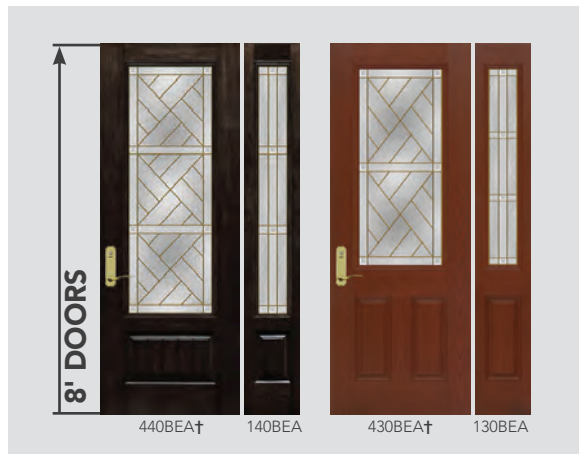
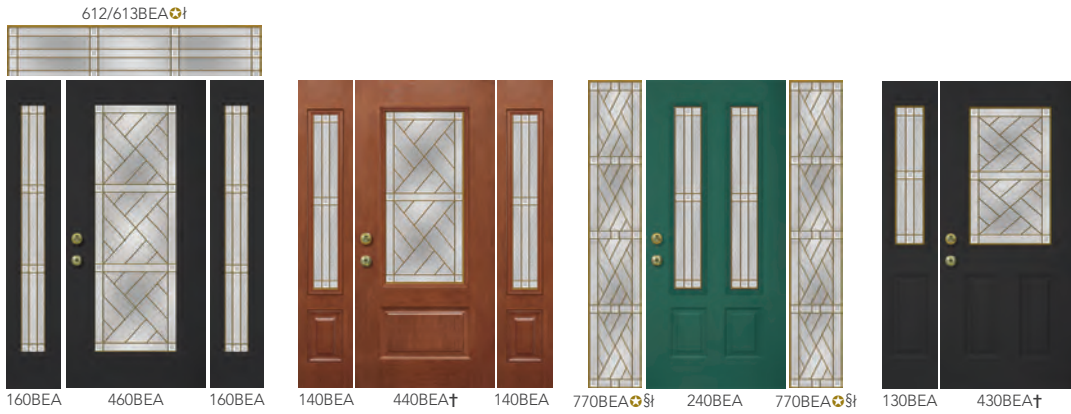

BERKLEY STYLE AVAILABILITY

	Doors						Sidelites					8' Doors		8' Sidelites	
	460	440	240	430	230	420	160	140	770	130	120	440	430	140	130
Embarq / Signet Mahogany Fiberglass	•	•		•			•	•	•	•					
Embarq / Signet Cherry Fiberglass	•	•		•			•	•	•	•		*		*	
Embarq / Signet Oak Fiberglass	•	•		•			•	•	•	•					
Signet Fir Fiberglass	•					•	•		•		•				
Signet Smooth Fiberglass	•	•				•	•	•	•						
Embarq / Signet Knotty Alder Fiberglass	•			•			•		•			*		*	
Heritage Woodgrain Textured Fiberglass	•	•		•	•		•	•	•	•		•		•	
Heritage Smooth Fiberglass	•	•		•	•		•	•	•	•		•		•	
20-Gauge Woodgrain Textured Steel	•	•	•	•			○	○	•	○					
20-Gauge Smooth Steel	•	•	•	•	•		○	○	•	○		•		•	

§ Also available in 10" width (which requires an additional 4-week lead time). See Price List for design pattern
 † Requires an additional 6-week lead time
 * Embarq doors and sidelites are not available in 8' heights

† For additional door panel styles see pg. 18 (for Embarq®), pg. 22 (for Signet®), pg. 24 (for Heritage™) or pg. 26 (for Legacy™)
 ○ Steel sidelites are made from 24-Gauge steel
 ‡ Cannot be mulled with Heritage Fiberglass doors in Certified Wind Load regions

LAURENCE

DECORATIVE GLASS

Laurence features a gray softwave expressing defined classical vintage that will greet your guests with its distinguished character and prominent lines.

CAMING FINISH

Patina

Clear Beveled

Patina Caming

Thin Reed

PRIVACY RATING

1 2 3 4 5 **6** 7 8 9 10

less privacy

more privacy

LIFETIME LIMITED WARRANTY

Includes Glass Breakage & Seal Failure

Clear Softwave

Gray Softwave



460LAU, 160LAU,



All Full Wood Frame and Composite Frame Entry Systems using Laurence Glass are ENERGY STAR® Certified and some Steel L-Frame Entry Systems using Laurence Glass are ENERGY STAR Certified. See the ENERGY STAR section of our website for energy ratings on specific styles.



LAURENCE STYLE AVAILABILITY

	Doors						Sidelites				8' Doors		8' Sidelites	
	460	440	240	430	230	420	160	140	130	120	440	430	140	130
Embarq / Signet Mahogany Fiberglass	•	•		•			•	•	•					
Embarq / Signet Cherry Fiberglass	•	•		•			•	•	•		*		*	
Embarq / Signet Oak Fiberglass	•	•		•			•	•	•					
Signet Fir Fiberglass	•					•	•			•				
Signet Smooth Fiberglass	•	•				•	•	•						
Embarq / Signet Knotty Alder Fiberglass	•			•			•					*		*
Heritage Woodgrain Textured Fiberglass	•	•		•	•	•	•	•	•		•		•	•
Heritage Smooth Fiberglass	•	•		•	•	•	•	•	•		•		•	•
20-Gauge Woodgrain Textured Steel	•	•	•	•	•	•	○	○	○					
20-Gauge Smooth Steel	•	•	•	•	•	•	○	○	○		•		•	•

† For additional door panel styles see pg. 18 (for Embarq®), pg. 22 (for Signet®), pg. 24 (for Heritage™) or pg. 26 (for Legacy™)

○ Steel sidelites are made from 24-Gauge steel

‡ Requires an additional 6-week lead time

* Embarq doors and sidelites are not available in 8' heights

⊗ Cannot be mulled with Heritage Fiberglass doors in Certified Wind Load regions

CARRINGTON

DECORATIVE GLASS

Flat Seedy

Carrington features small hammered, flat seedy and clear bevels in an attractive vintage design to accent your home's entryway.

CAMING FINISH

Patina

Patina Caming

Clear Beveled

PRIVACY RATING

1 2 3 4 **5** 6 7 8 9 10

less privacy

more privacy

Small Hammered

LIFETIME LIMITED WARRANTY

Includes Glass Breakage & Seal Failure



460CAR, 160CAR



All Full Wood Frame and Composite Frame Entry Systems using Carrington Glass are ENERGY STAR® Certified and some Steel L-Frame Entry Systems using Carrington Glass are ENERGY STAR Certified. See the ENERGY STAR section of our website for energy ratings on specific styles.



Carrington Glass

CARRINGTON STYLE AVAILABILITY

	Doors									Sidelites					8' Doors			8' Sidelites	
	460	440	449	240	243	430	230	420	419	160	140	770	130	120	440	430	437	140	130
Embarq / Signet Mahogany Fiberglass	•	•				•			•	•	•	•	•						
Embarq / Signet Cherry Fiberglass	•	•	•			•			•	•	•	•	•		*				*
Embarq / Signet Oak Fiberglass	•	•				•			•	•	•	•	•						
Signet Fir Fiberglass	•							•		•				•					
Signet Smooth Fiberglass	•	•						•		•	•	•							
Embarq / Signet Knotty Alder Fiberglass	•					•				•	•				*	*			*
Heritage Woodgrain Textured Fiberglass	•	•				•	•	•	•	•	•	•	•		•				•
Heritage Smooth Fiberglass	•	•				•	•	•	•	•	•	•	•		•				•
20-Gauge Woodgrain Textured Steel	•	•		•		•			•	○	○	•	○						
20-Gauge Smooth Steel	•	•		•		•	•		•	○	○	•	○		•				•

§ Also available in 10" width (which requires an additional 4-week lead time). See Price List for design pattern
 † Requires an additional 6-week lead time
 * Embarq doors and sidelites are not available in 8' heights

† For additional door panel styles see pg. 18 (for Embarq®), pg. 22 (for Signet®), pg. 24 (for Heritage™) or pg. 26 (for Legacy™)
 ○ Steel sidelites are made from 24-Gauge steel
 ✪ Cannot be mulled with Heritage Fiberglass doors in Certified Wind Load regions

TACOMA

DECORATIVE GLASS

Tacoma features hammered and micro-granite design reminiscent of the Arts and Crafts period. Tacoma adds a southwestern inspired theme bringing heritage and legacy to your door.

CAMING FINISH

Patina

PRIVACY RATING

1 2 3 4 5 **6** 7 8 9 10

less privacy

more privacy

LIFETIME LIMITED WARRANTY

Includes Glass Breakage & Seal Failure

Clear Beveled

Micro-granite

Thin Reed

Small Hammered

Patina Caming



420TAC-DS, 160TAC, 612/613TAC



All Full Wood Frame and Composite Frame Entry Systems using Tacoma Glass are ENERGY STAR® Certified and some Steel L-Frame Entry Systems using Tacoma Glass are ENERGY STAR Certified. See the ENERGY STAR section of our website for energy ratings on specific styles.



Tacoma Glass

TACOMA STYLE AVAILABILITY

	Doors				Sidelites			8' Doors		8' Sidelites	
	460	440	240	420	160	140	120	440	430	140	130
Embarq / Signet Mahogany Fiberglass	●	●			●	●					
Embarq / Signet Cherry Fiberglass	●	●			●	●		*		*	
Embarq / Signet Oak Fiberglass	●	●			●	●					
Embarq / Signet Knotty Alder Fiberglass	●				●				*		*
Signet Fir Fiberglass	●			●	●		●				
Signet Smooth Fiberglass	●	●		●	●	●					
Heritage Woodgrain Textured Fiberglass	●	●			●	●			●		●
Heritage Smooth Fiberglass	●	●			●	●			●		●
20-Gauge Woodgrain Textured Steel	●	●	●		○	○					
20-Gauge Smooth Steel	●	●	●		○	○			●		●

† For additional door panel styles see pg. 18 (for Embarq®), pg. 22 (for Signet®), pg. 24 (for Heritage™) or pg. 26 (for Legacy™)

○ Steel sidelites are made from 24-Gauge steel

† Requires an additional 6-week lead time

* Embarq doors and sidelites are not available in 8' heights

⚠ Cannot be mullied with Heritage Fiberglass doors in Certified Wind Load regions

SOMERSET

DECORATIVE GLASS

Somerset features small hammered, micro granite and clear bevels in a simple yet elegant design that gives a fresh look to your entryway.

CAMING FINISH

Zinc

PRIVACY RATING

1 2 3 4 5 **6** 7 8 9 10

less privacy

more privacy

Zinc Caming

Micro-granite

Clear Beveled

Small Hammered

LIFETIME LIMITED WARRANTY

Includes Glass Breakage & Seal Failure



449SOM-1P, 140SOM



All Full Wood Frame Entry Systems using Somerset Glass are ENERGY STAR® Certified and some Steel L-Frame Entry Systems using Somerset Glass are ENERGY STAR Certified. See the ENERGY STAR section of our website for energy ratings on specific styles.

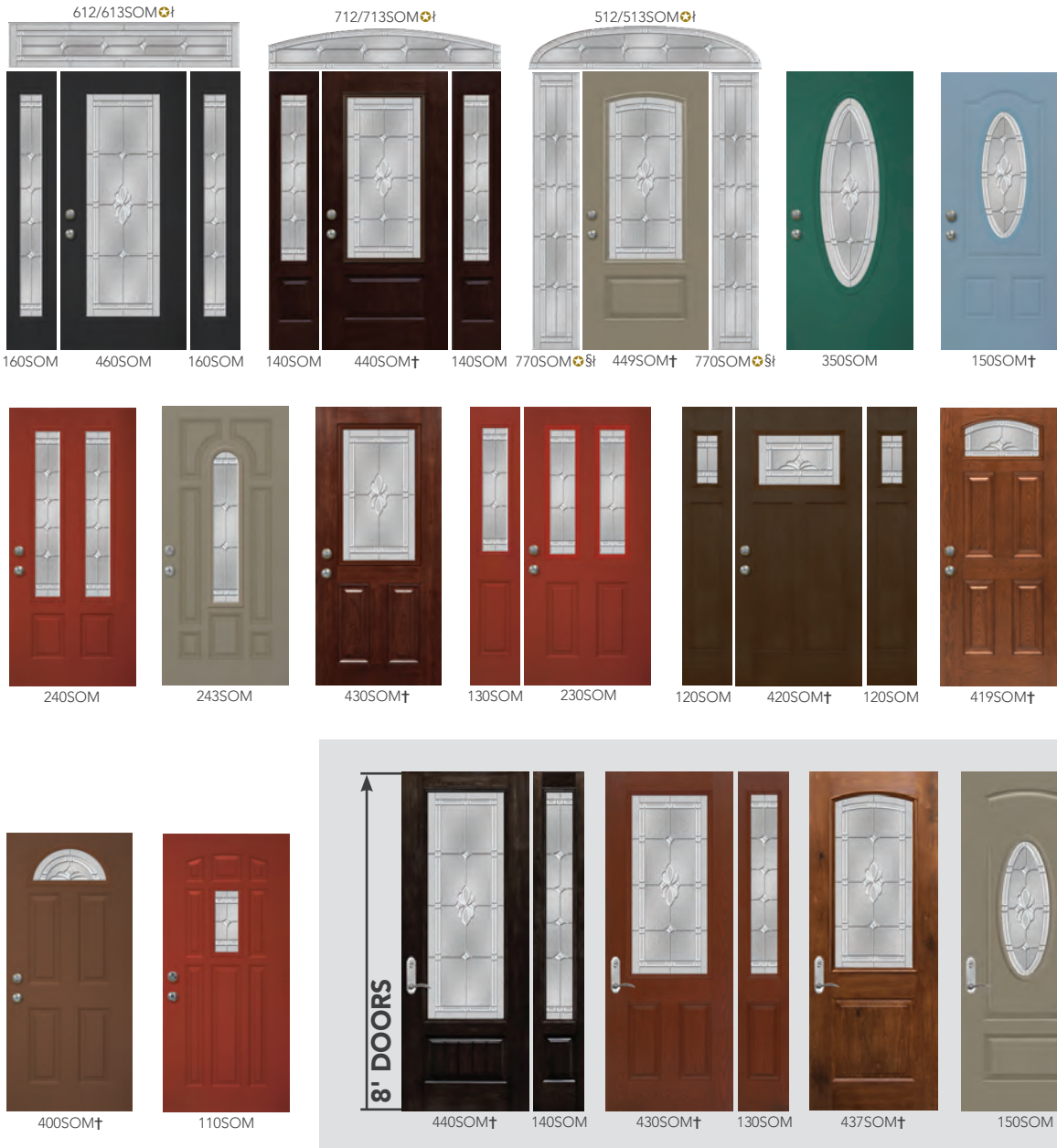

SOMERSET STYLE AVAILABILITY

	Doors											Sidelites					8' Doors				8' Sidelites				
	460	440	449	350	150	240	243	430	230	420	419	400	110	160	140	770	130	120	440	430	437	150	140	130	
Embarq / Signet Mahogany Fiberglass	•	•			•			•			•			•	•	•	•								
Embarq / Signet Cherry Fiberglass	•	•	•		•			•			•			•	•	•	•		*		*			*	
Embarq / Signet Oak Fiberglass	•	•			•			•			•			•	•	•	•								
Signet Fir Fiberglass	•									•				•		•		•							
Embarq / Signet Knotty Alder Fiberglass	•							•						•	•					*	*			*	
Signet Smooth Fiberglass	•	•			•					•				•	•	•									
Heritage Woodgrain Textured Fiberglass	•	•		•	•			•	•	•	•	•	•	•	•	•	•				•			•	
Heritage Smooth Fiberglass	•	•		•	•			•	•	•	•	•	•	•	•	•	•				•			•	
20-Gauge Woodgrain Textured Steel	•	•		•	•			•	•	•	•	•	•	•	•	•	•	•	•	•	•			•	
20-Gauge Smooth Steel	•	•		•	•			•	•	•	•	•	•	•	•	•	•	•	•	•	•			•	

§ Also available in 10" width. See Price List for design pattern

† Requires an additional 6-week lead time

o Steel sidelites are made from 24-Gauge steel

* Embarq doors and sidelites are not available in 8' heights

† For additional door panel styles see pg. 18 (for Embarq®), pg. 22 (for Signet®), pg. 24 (for Heritage™) or pg. 26 (for Legacy™)

⊕ Cannot be mulled with Heritage Fiberglass doors in Certified Wind Load regions

CARMEN

WROUGHT IRON DECORATIVE GLASS

Carmen features a refreshing new style for an entrance way with old world style charm. Standard with Chinchilla privacy glass and also available in all privacy glass options.

Wrought Iron with Nickel-Veined Finish

Chinchilla

CHINCHILLA PRIVACY RATING

1 2 3 4 5 6 7 8 **9** 10

less privacy

more privacy

LIFETIME LIMITED WARRANTY

Includes Glass Breakage & Seal Failure



460CRM, 160CRM



All Full Wood Frame and Composite Frame Entry Systems using Carmen Glass are ENERGY STAR® Certified and some Steel L-Frame Entry Systems using Carmen Glass are ENERGY STAR Certified. See the ENERGY STAR section of our website for energy ratings on specific styles.

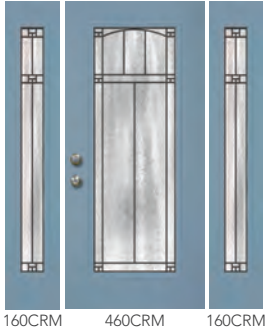

When you order Carmen glass using the style code CRM, you will receive the standard Chinchilla glass. To order the other Privacy Glass options shown below, use the style codes GLC, TAF, WAT or OBS after the letters CRM (e.g. 460CRM-GLC).



GLUECHIP

PRIVACY RATING



less privacy more privacy



TAFFETA

PRIVACY RATING



less privacy more privacy

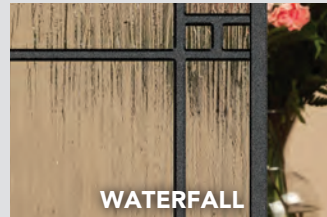

WATERFALL

PRIVACY RATING



less privacy more privacy

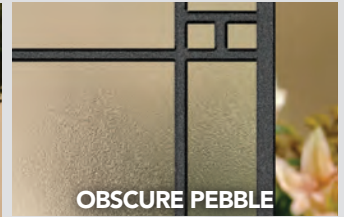

OBSCURE PEBBLE

PRIVACY RATING



less privacy more privacy

CARMEN STYLE AVAILABILITY

	Doors						Sidelites				8' Doors		8' Sidelites	
	460	440	240	430	230	420	160	140	130	120	440	430	140	130
Embarq / Signet Mahogany Fiberglass	●	●		●			●	●	●					
Embarq / Signet Cherry Fiberglass	●	●		●			●	●	●		*		*	
Embarq / Signet Oak Fiberglass	●	●		●			●	●	●					
Signet Fir Fiberglass	●					●	●			●				
Embarq / Signet Knotty Alder Fiberglass	●			●			●					*		*
Signet Smooth Fiberglass	●	●				●	●	●						
Heritage Woodgrain Textured Fiberglass	●	●		●	●		●	●	●			●		●
Heritage Smooth Fiberglass	●	●		●	●		●	●	●			●		●
20-Gauge Woodgrain Textured Steel	●	●	●	●	●		○	○	○					
20-Gauge Smooth Steel	●	●	●	●	●		○	○	○			●		●

† Requires an additional 6-week lead time

* Embarq doors and sidelites are not available in 8' heights

† For additional door panel styles see pg. 18 (for Embarq®), pg. 22 (for Signet®), pg. 24 (for Heritage™) or pg. 26 (for Legacy™)

○ Steel sidelites are made from 24-Gauge steel

✘ Cannot be mulled with Heritage Fiberglass doors in Certified Wind Load regions

BARCELONA

WROUGHT IRON DECORATIVE GLASS

Barcelona features an exquisite wrought iron design with the option of choosing gluechip (standard), waterfall, taffeta, chinchilla, obscure pebble or clear glass.

Black Wrought Iron

Gluechip

GLUECHIP PRIVACY RATING

1 2 3 4 5 6 7 **8** 9 10

less privacy

more privacy

LIFETIME LIMITED WARRANTY

Includes Glass Breakage & Seal Failure



8' 440BRC-1P, 140BRC



All Full Wood Frame and Composite Frame Entry Systems using Barcelona Glass are ENERGY STAR® Certified and some Steel L-Frame Entry Systems using Barcelona Glass are ENERGY STAR Certified. See the ENERGY STAR section of our website for energy ratings on specific styles.

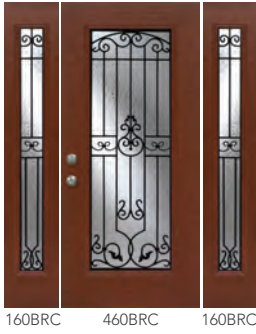

Barcelona Glass

When you order Barcelona glass using the style code BRC, you will receive the standard Gluechip glass. To order the other Privacy Glass options shown below, use the style codes CHI, TAF, WAT or OBS after the letters BRC (e.g. 460BRC-CHI).

CHINCHILLA	TAFFETA	WATERFALL	OBSCURE PEBBLE
PRIVACY RATING	PRIVACY RATING	PRIVACY RATING	PRIVACY RATING
1 2 3 4 5 6 7 8 9 10	1 2 3 4 5 6 7 8 9 10	1 2 3 4 5 6 7 8 9 10	1 2 3 4 5 6 7 8 9 10
less privacy more privacy	less privacy more privacy	less privacy more privacy	less privacy more privacy

BARCELONA STYLE AVAILABILITY

	Doors					Sidelites			8' Doors		8' Sidelites	
	460	440	240	430	230	160	140	130	440	430	140	130
Embarq / Signet Mahogany Fiberglass	•	•		•		•	•	•				
Embarq / Signet Cherry Fiberglass	•	•		•		•	•	•	*		*	
Embarq / Signet Oak Fiberglass	•	•		•		•	•	•				
Embarq / Signet Knotty Alder Fiberglass	•			•		•				*		*
Signet Fir Fiberglass	•					•						
Signet Smooth Fiberglass	•	•				•	•					
Heritage Woodgrain Textured Fiberglass	•	•		•	•	•	•	•		•		•
Heritage Smooth Fiberglass	•	•		•	•	•	•	•		•		•
20-Gauge Woodgrain Textured Steel	•	•	•	•	•	○	○	○				
20-Gauge Smooth Steel	•	•	•	•	•	○	○	○		•		•

† For additional door panel styles see pg. 18 (for Embarq®), pg. 22 (for Signet®), pg. 24 (for Heritage™) or pg. 26 (for Legacy™)
 ○ Steel sidelites are made from 24-Gauge steel
 * Embarq doors and sidelites are not available in 8' heights

CONSTANCE

DECORATIVE GLASS

Constance features gluechip, medium gray softwave and beveled edge glue chip resulting in a traditional design that gives your entryway an elegant look.

CAMING FINISH

Brass

Zinc

Specify caming finish using these codes:
Brass - COB, Zinc - COZ

PRIVACY RATING

1 2 3 4 5 **6** 7 8 9 10

less privacy

more privacy

LIFETIME LIMITED WARRANTY

Includes Glass Breakage & Seal Failure

Caming

Gluechip

Beveled Edge Gluechip

Medium Gray Softwave



449COB-1P, 770COB, 512/513COB



All Full Wood Frame and Composite Frame Entry Systems using Constance Glass are ENERGY STAR® Certified and some Steel L-Frame Entry Systems using Constance Glass are ENERGY STAR Certified. See the ENERGY STAR section of our website for energy ratings on specific styles.



CONSTANCE STYLE AVAILABILITY

	Doors											Sidelites					8' Doors				8' Sidelites			
	460	440	449	350	150	240	243	430	230	420	419	400	110	160	140	770	130	120	440	430	437	150	140	130
Embarq / Signet Mahogany Fiberglass	•	•			•			•			•			•	•	•	•							
Embarq / Signet Cherry Fiberglass	•	•	•			•		•			•			•	•	•	•			*		*		*
Embarq / Signet Oak Fiberglass	•	•				•		•			•			•	•	•	•							
Signet Fir Fiberglass	•									•				•		•		•						
Signet Smooth Fiberglass	•	•			•					•				•	•	•								
Embarq / Signet Knotty Alder Fiberglass	•							•						•		•				*		*		*
Heritage Woodgrain Textured Fiberglass	•	•		•	•		•	•	•	•	•	•	•	•	•	•	•							•
Heritage Smooth Fiberglass	•	•		•	•		•	•	•	•	•	•	•	•	•	•	•							•
20-Gauge Woodgrain Textured Steel	•	•		•		•		•		•	•			○	○	○	○							
20-Gauge Smooth Steel	•	•		•	•	•		•	•	•	•	•	•	○	○	•	○							•

§ Also available in 10" width (which requires an additional 4-week lead time). See Price List for design pattern

† Requires an additional 6-week lead time

* Embarq doors and sidelites are not available in 8' heights

† For additional door panel styles see pg. 18 (for Embarq®), pg. 22 (for Signet®), pg. 24 (for Heritage™) or pg. 26 (for Legacy™)

○ Steel sidelites are made from 24-Gauge steel

✦ Cannot be mulled with Heritage Fiberglass doors in Certified Wind Load regions

TRANQUILITY

DECORATIVE GLASS

Tranquility features unique Chinchilla glass accented with beveled clusters and streamed glass.

CAMING FINISH

Patina

Zinc

Specify caming finish using these codes:
Patina - TRP, Zinc - TRZ

PRIVACY RATING

1 2 3 4 5 6 7 **8** 9 10

less privacy

more privacy

LIFETIME LIMITED WARRANTY

Includes Glass Breakage & Seal Failure

Streamed

Chinchilla

Granite

Caming



350BRZ, 160BRZ



All Full Wood Frame and Composite Frame Entry Systems using Tranquility Glass are ENERGY STAR® Certified and some Steel L-Frame Entry Systems using Tranquility Glass are ENERGY STAR Certified. See the ENERGY STAR section of our website for energy ratings on specific styles.



Tranquility Glass

TRANQUILITY STYLE AVAILABILITY

	Doors											Sidelites			8' Doors			8' Sidelites		
	460	440	350	150	240	243	430	230	419	400	110	160	140	130	440	430	150	140	130	
Embarq / Signet Mahogany Fiberglass	•	•		•			•		•			•	•	•						
Embarq / Signet Cherry Fiberglass	•	•		•			•		•			•	•	•	*		*		*	
Embarq / Signet Oak Fiberglass	•	•		•			•		•			•	•	•						
Embarq / Signet Knotty Alder Fiberglass	•						•					•					*			*
Signet Fir Fiberglass	•											•								
Signet Smooth Fiberglass	•	•		•								•	•							
Heritage Woodgrain Textured Fiberglass	•	•	•	•			•	•	•	•	•	•	•	•						•
Heritage Smooth Fiberglass	•	•	•	•			•	•	•	•	•	•	•	•						•
20-Gauge Woodgrain Textured Steel	•	•	•		•		•	•	•	•		○	○	○						
20-Gauge Smooth Steel	•	•	•	•	•		•	•	•	•	•	○	○	○						•

† For additional door panel styles see pg. 18 (for Embarq®), pg. 22 (for Signet®), pg. 24 (for Heritage™) or pg. 26 (for Legacy™)
 ○ Steel sidelites are made from 24-Gauge steel
 ‡ Requires an additional 6-week lead time
 * Embarq doors and sidelites are not available in 8' heights
 ☼ Cannot be mulled with Heritage Fiberglass doors in Certified Wind Load regions

GEMSTONE

DECORATIVE GLASS

Beautiful beveled glass with iced and micro-iced granite, accented with zinc caming, gives this classic design a contemporary edge.

CAMING FINISH

Zinc

Zinc Caming

PRIVACY RATING

1 2 3 4 5 6 7 **8** 9 10

less privacy

more privacy

Alabaster

Micro-iced Granite

Clear Beveled

Iced Granite

LIFETIME LIMITED WARRANTY

Includes Glass Breakage & Seal Failure





All Full Wood Frame and Composite Frame Entry Systems using Gemstone Glass are ENERGY STAR® Certified and some Steel L-Frame Entry Systems using Gemstone Glass are ENERGY STAR Certified. See the ENERGY STAR section of our website for energy ratings on specific styles.



Gemstone Glass

GEMSTONE STYLE AVAILABILITY

	Doors								Sidelites			8' Doors			8' Sidelites	
	460	440	150	240	243	430	230	419	160	140	130	440	430	150	140	130
Embarq / Signet Mahogany Fiberglass	•	•	•			•		•	•	•	•					
Embarq / Signet Cherry Fiberglass	•	•	•		•	•		•	•	•	•	*		*		*
Embarq / Signet Oak Fiberglass	•	•	•		•	•		•	•	•	•					
Embarq / Signet Knotty Alder Fiberglass	•					•							*			*
Signet Fir Fiberglass	•	•	•						•	•						
Signet Smooth Fiberglass	•								•							
Heritage Woodgrain Textured Fiberglass	•	•	•		•	•	•	•	•	•	•		•			•
Heritage Smooth Fiberglass	•	•	•		•	•	•	•	•	•	•		•			•
20-Gauge Woodgrain Textured Steel	•	•	•	•		•		•	○	○	○					
20-Gauge Smooth Steel	•	•	•	•		•	•	•	○	○	○		•			•

† For additional door panel styles see pg. 18 (for Embarq®), pg. 22 (for Signet®), pg. 24 (for Heritage™) or pg. 26 (for Legacy™)

○ Steel sidelites are made from 24-Gauge steel

‡ Requires an additional 6-week lead time

* Embarq doors and sidelites are not available in 8' heights

⊕ Cannot be mulled with Heritage Fiberglass doors in Certified Wind Load regions

ECLIPSE

DECORATIVE GLASS

Eclipse features double gluechip and clusters of bevel with a traditional and harmonious design. Eclipse promotes classical elegance and privacy.

CAMING FINISH



Specify caming finish using these codes:
 Brass - ECB, Zinc - ECZ, Patina - ECP

PRIVACY RATING



LIFETIME LIMITED WARRANTY
 Includes Glass Breakage & Seal Failure





All Full Wood Frame and Composite Frame Entry Systems using Eclipse Glass are ENERGY STAR® Certified and some Steel L-Frame Entry Systems using Eclipse Glass are ENERGY STAR Certified. See the ENERGY STAR section of our website for energy ratings on specific styles.



ECLIPSE STYLE AVAILABILITY

	Doors										Sidelites		8' Doors		8' Sidelites
	460	350	150	243	430	439	230	419	400	110	160	130	440	150	140
Embarq / Signet Mahogany Fiberglass	•		•		•			•			•	•			
Embarq / Signet Cherry Fiberglass	•		•	•	•			•			•	•	*	*	*
Embarq / Signet Oak Fiberglass	•		•	•	•			•			•	•			
Embarq / Signet Knotty Alder Fiberglass	•				•						•				
Signet Fir Fiberglass	•										•				
Signet Smooth Fiberglass	•		•								•				
Heritage Woodgrain Textured Fiberglass	•	•	•	•	•	•	•	•	•		•	•			
Heritage Smooth Fiberglass	•	•	•	•	•	•	•	•	•		•	•			
20-Gauge Woodgrain Textured Steel	•	•	•		•	•	•	•	•		○	○			
20-Gauge Smooth Steel	•	•	•		•	•	•	•	•		○	○			

† For additional door panel styles see pg. 18 (for Embarq®), pg. 22 (for Signet®), pg. 24 (for Heritage™) or pg. 26 (for Legacy™)

○ Steel sidelites are made from 24-Gauge steel

† Requires an additional 6-week lead time

* Embarq doors and sidelites are not available in 8' heights

⊛ Cannot be mulled with Heritage Fiberglass doors in Certified Wind Load regions

FLORENCE

DECORATIVE GLASS

This traditional style is accented with a creamy alabaster glass adding interest and appeal that clearly sets it apart from other decorative designs.

CAMING FINISH

Brass

Patina

Specify caming finish using these codes:
Brass - FLB, Patina - FLP

PRIVACY RATING

1 2 3 4 5 6 7 **8** 9 10

less privacy

more privacy

LIFETIME LIMITED WARRANTY

Includes Glass Breakage & Seal Failure

Micro-iced Granite

Clear Beveled

Caming

Alabaster

Hammered





All Full Wood Frame and Composite Frame Entry Systems using Florence Glass are ENERGY STAR® Certified and some Steel L-Frame Entry Systems using Florence Glass are ENERGY STAR Certified. See the ENERGY STAR section of our website for energy ratings on specific styles.

612/613FLP†



160FLP 460FLP 160FLP



140FLP 440FLP† 140FLP



160FLP 350FLP 160FLP



150FLP†

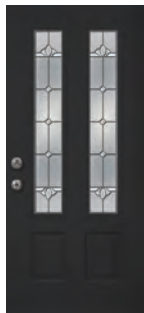

240FLP



243FLP

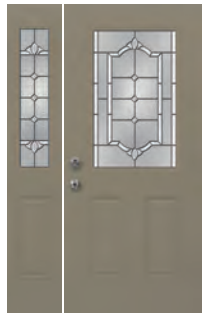

130FLP 430FLP†



230FLP



419FLP†



400FLP†



8' DOORS

440FLP† 140FLP 430FLP† 130FLP 150FLP

FLORENCE STYLE AVAILABILITY

	Doors										Sidelites			8' Doors			8' Sidelites	
	460	440	350	150	240	243	430	230	419	400	160	140	130	440	430	150	140	130
Embarq / Signet Mahogany Fiberglass	•	•		•			•		•		•	•	•					
Embarq / Signet Cherry Fiberglass	•	•		•		•	•		•		•	•	•	*		*		*
Embarq / Signet Oak Fiberglass	•	•		•		•	•		•		•	•	•					
Embarq / Signet Knotty Alder Fiberglass	•						•				•				*			*
Heritage Woodgrain Textured Fiberglass	•	•	•	•		•	•	•	•	•	•	•	•			•		•
Signet Fir Fiberglass	•																	
Signet Smooth Fiberglass	•	•		•							•	•						
Heritage Smooth Fiberglass	•	•	•	•		•	•	•	•	•	•	•	•			•		•
20-Gauge Woodgrain Textured Steel	•	•	•	•		•	•	•	•	•	○	○	○					
20-Gauge Smooth Steel	•	•	•	•	•		•	•	•	•	○	○	○			•		•

† For additional door panel styles see pg. 18 (for Embarq®), pg. 22 (for Signet®), pg. 24 (for Heritage™) or pg. 26 (for Legacy™)

○ Steel sidelites are made from 24-Gauge steel

† Requires an additional 6-week lead time

* Embarq doors and sidelites are not available in 8' heights

✪ Cannot be mulled with Heritage Fiberglass doors in Certified Wind Load regions

Florence Glass

ESMOND

DECORATIVE GLASS

Esmond features small hammered, micro-granite, flat seedy and clear bevels in a splendid old-world style design bringing a unique touch to your entryway.

CAMING FINISH

Patina

PRIVACY RATING

1 2 3 4 5 **6** 7 8 9 10

less privacy

more privacy

Small Hammered

Flat Seedy

Caming

Clear Beveled

Micro-granite

LIFETIME LIMITED WARRANTY

Includes Glass Breakage & Seal Failure



460ESM, 160ESM



All Full Wood Frame and Composite Frame Entry Systems using Esmond Glass are ENERGY STAR® Certified and some Steel L-Frame Entry Systems using Esmond Glass are ENERGY STAR Certified. See the ENERGY STAR section of our website for energy ratings on specific styles.



Esmond Glass

ESMOND STYLE AVAILABILITY

	Doors												Sidelites					8' Doors				8' Sidelites					
	460	440	449	350	150	240	243	430	439	230	239	420	419	400	160	140	770	130	139	120	440	430	437	150	140	130	
Embarq / Signet Mahogany Fiberglass	•	•			•			•					•		•	•	•	•									
Embarq / Signet Cherry Fiberglass	•	•	•		•		•	•					•		•	•	•	•					*		*	*	
Embarq / Signet Oak Fiberglass	•	•			•		•	•					•		•	•	•	•									
Signet Fir Fiberglass	•											•			•					•							
Embarq / Signet Knotty Alder Fiberglass	•							•							•		•						*	*		*	
Signet Smooth Fiberglass	•	•			•							•			•	•	•										
Heritage Woodgrain Textured Fiberglass	•	•		•		•	•	•	•				•	•	•	•	•	•					•			•	
Heritage Smooth Fiberglass	•	•		•		•	•	•	•				•	•	•	•	•	•					•			•	
20-Gauge Woodgrain Textured Steel	•	•		•		•	•	•	•				•	•	○	○	•	○	○								
20-Gauge Smooth Steel	•	•		•	•	•	•	•	•	•			•	•	○	○	•	○	○				•			•	

§ Also available in 10" width (which requires an additional 4-week lead time). See Price List for design pattern
 † Requires an additional 6-week lead time
 * Embarq doors and sidelites are not available in 8' heights

† For additional door panel styles see pg. 18 (for Embarq®), pg. 22 (for Signet®), pg. 24 (for Heritage™) or pg. 26 (for Legacy™)
 ○ Steel sidelites are made from 24-Gauge steel
 ☉ Cannot be mulled with Heritage Fiberglass doors in Certified Wind Load regions

CARLISLE

DECORATIVE GLASS

Carlisle features clear bevels, arctic and seedy glass giving an appealing entranceway to any style of home.

CAMING FINISH

Patina

Zinc

Specify caming finish using these codes:
Patina - CRP, Zinc - CRZ

PRIVACY RATING

1 2 3 4 5 6 **7** 8 9 10

less privacy

more privacy

LIFETIME LIMITED WARRANTY

Includes Glass Breakage & Seal Failure

Clear Beveled

Caming

Arctic

Seedy



460CRP, 160CRP, 712/713CRP



All Full Wood Frame and Composite Frame Entry Systems using Carlisle Glass are ENERGY STAR® Certified and some Steel L-Frame Entry Systems using Carlisle Glass are ENERGY STAR Certified. See the ENERGY STAR section of our website for energy ratings on specific styles.



Carlisle Glass

CARLISLE STYLE AVAILABILITY

	Doors											Sidelites					8' Doors				8' Sidelites			
	460	440	449	350	150	240	243	430	230	420	419	400	160	140	770	130	120	440	430	437	150	140	130	
Embarq / Signet Mahogany Fiberglass	•	•			•			•			•		•	•	•	•								
Embarq / Signet Cherry Fiberglass	•	•	•		•		•	•			•		•	•	•	•			*		*		*	
Embarq / Signet Oak Fiberglass	•	•			•		•	•			•		•	•	•	•								
Signet Fir Fiberglass	•									•							•							
Embarq / Signet Knotty Alder Fiberglass	•							•					•	•					*	*				*
Signet Smooth Fiberglass	•	•			•					•			•	•	•									
Heritage Woodgrain Textured Fiberglass	•	•		•	•		•	•	•		•	•	•	•	•	•			•				•	
Heritage Smooth Fiberglass	•	•		•	•		•	•	•		•	•	•	•	•				•				•	
20-Gauge Woodgrain Textured Steel	•	•		•	•		•	•	•		•	•	•	•	•	•	•	•	•					
20-Gauge Smooth Steel	•	•		•	•	•	•	•	•		•	•	•	•	•	•	•	•	•					•

§ Also available in 10" width (which requires an additional 4-week lead time). See Price List for design pattern

† Requires an additional 6-week lead time

* Embarq doors and sidelites are not available in 8' heights

† For additional door panel styles see pg. 18 (for Embarq®), pg. 22 (for Signet®), pg. 24 (for Heritage™) or pg. 26 (for Legacy™)

○ Steel sidelites are made from 24-Gauge steel

⊕ Cannot be mulled with Heritage Fiberglass doors in Certified Wind Load regions

TWILIGHT

DECORATIVE GLASS

Twilight is a beautifully decorative silk-screened art. It's unique frosted glass adds to the warmth and privacy of your home.

PRIVACY RATING

1 2 3 4 5 6 7 **8** 9 10

less privacy

more privacy

Clear

Frosted

LIFETIME LIMITED WARRANTY

Includes Glass Breakage & Seal Failure



430TWI-2P



All Full Wood Frame and Composite Frame Entry Systems using Twilight Glass are ENERGY STAR® Certified and some Steel L-Frame Entry Systems using Twilight Glass are ENERGY STAR Certified. See the ENERGY STAR section of our website for energy ratings on specific styles.



160TWI 350TWI 160TWI



130TWI 430TWI† 430TWI† 130TWI



130TWI 230TWI



400TWI†



160TWI 110TWI 160TWI

TWILIGHT STYLE AVAILABILITY

	Doors					Sidelites	
	350	430	230	400	110	160	130
Signet Mahogany Fiberglass		•					•
Signet Cherry Fiberglass		•					•
Signet Oak Fiberglass		•					•
Signet Knotty Alder Fiberglass		•				•	
Heritage Woodgrain Textured Fiberglass	•	•	•	•		•	•
Heritage Smooth Fiberglass	•	•	•	•		•	•
20-Gauge Woodgrain Textured Steel	•	•		•		○	○
20-Gauge Smooth Steel	•	•	•	•	•	○	○

† For additional door panel styles see pg. 18 (for Embarq®), pg. 22 (for Signet®), pg. 24 (for Heritage™) or pg. 26 (for Legacy™)

○ Steel sidelites are made from 24-Gauge steel

BRAINSTORM

DIALOGUE LAYERED GLASS™

Appealing to both mid-modern and modern design sensibilities, Brainstorm's exterior vertical pattern and interior chevron motif combine for an appearance with both subtlety and substance. Brainstorm layered glass has a medium to medium-high privacy range.

PRIVACY RATING

1 2 3 4 5 **6** 7 8 9 10

less privacy

more privacy

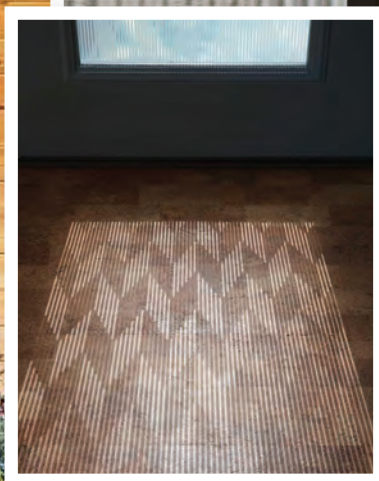



BRAINSTORM STYLE AVAILABILITY

	Doors			Sidelites	8' Doors			8' Sidelites
	460	440	430	160	460	440	430	160
Signet Mahogany Fiberglass	•	•	•	•				
Signet Cherry Fiberglass	•	•	•	•		•		
Signet Oak Fiberglass	•	•	•	•				
Signet Knotty Alder Fiberglass	•		•	•			•	
Signet Fir Fiberglass	•			•				
Signet Smooth Fiberglass	•	•	•	•				
Heritage Woodgrain Textured Fiberglass	•	•	•	•	•		•	•
Heritage Smooth Fiberglass	•	•	•	•	•		•	•
20-Gauge Woodgrain Textured Steel	•	•	•	○				
20-Gauge Smooth Steel	•	•	•	○	•		•	•

† For additional door panel styles see pg. 18 (for Embarq®), pg. 22 (for Signet®), pg. 24 (for Heritage™) or pg. 26 (for Legacy™)
 ○ Steel sidelites are made from 24-Gauge steel

REPARTEE

DIALOGUE LAYERED GLASS™

Repartee's frosted layers and geometric grid combine for a design that plays with opacity and movement. Squares and trapezoids carry on a lively back-and-forth as light and vantage points change their appearance. Repartee layered glass offers a high privacy range.

PRIVACY RATING

1 2 3 4 5 6 7 **8** 9 10

less privacy

more privacy

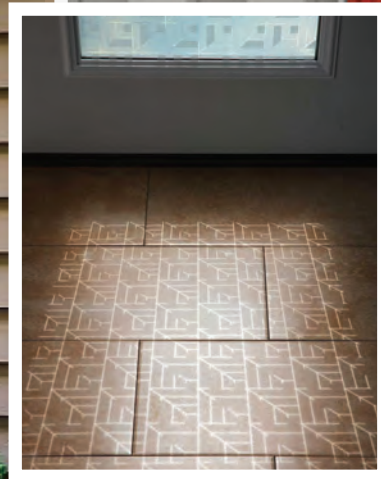



REPATEE STYLE AVAILABILITY

	Doors			Sidelites	8' Doors			8' Sidelites
	460	440	430	160	460	440	430	160
Signet Mahogany Fiberglass	•	•	•	•				
Signet Cherry Fiberglass	•	•	•	•		•		
Signet Oak Fiberglass	•	•	•	•				
Signet Knotty Alder Fiberglass	•		•	•			•	
Signet Fir Fiberglass	•			•				
Signet Smooth Fiberglass	•	•	•	•				
Heritage Woodgrain Textured Fiberglass	•	•	•	•	•		•	•
Heritage Smooth Fiberglass	•	•	•	•	•		•	•
20-Gauge Woodgrain Textured Steel	•	•	•	○				
20-Gauge Smooth Steel	•	•	•	○	•		•	•

† For additional door panel styles see pg. 18 (for Embarq®), pg. 22 (for Signet®), pg. 24 (for Heritage™) or pg. 26 (for Legacy™)

○ Steel sidelites are made from 24-Gauge steel

INSPIRATIONS™

ART GLASS

A ProVia exclusive, Inspirations Art Glass allows you to do just what the name suggests-let your doors and windows reflect the inspiration of your imagination with your choice of design and color.

DESIGNS

The process begins with conceptual design. Our twelve beautiful Inspirations Art Glass styles originated from the imagination of our in-house designers.

RESIN BEAD

The design pattern is created on our computer software, and sent to a CNC machine which applies a resin bead to the surface of the glass in one of our four stylish colors.

COLOR FILL

The color fill truly brings the glass to life. Five distinct color palettes are offered empowering you to perfectly reflect the personality of you and your home. Our craftsmen hand-apply this color fill to your glass.

OUR GUARANTEE

The resin bead and color fill are backed by our Lifetime Limited Warranty, and will not fade, blister or peel away from the glass.





SEE MORE INSPIRATIONS

Ask to see our Inspirations Art Glass brochure for available styles and color palettes, or use our ProVia app to create custom color palettes and design your dream door.



Download our free app today!



Download on entryLINK
or provia.com/app



NEW
Style Available

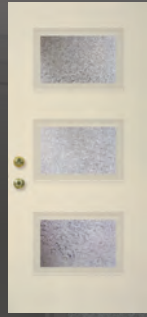

113

115OBS, 770OBS

PRIVACY GLASS

CHINCHILLA (CHI)

PRIVACY RATING

1 2 3 4 5 6 7 8 **9** 10

less privacy

more privacy



TAFFETA (TAF)

PRIVACY RATING

1 2 3 4 5 6 7 8 **9** 10

less privacy

more privacy



WATERFALL (WAT)

PRIVACY RATING

1 2 3 4 5 6 7 8 **9** 10

less privacy

more privacy



GLUECHIP (GLC)

PRIVACY RATING

1 2 3 4 5 6 7 **8** 9 10

less privacy

more privacy



OBSCUR PEBBLE (OBS)

PRIVACY RATING

1 2 3 4 5 6 7 8 **9** 10

less privacy

more privacy



Privacy glass allows light to filter in, while keeping a high level of privacy.

LIFETIME LIMITED WARRANTY

Includes Glass Breakage & Seal Failure

PRIVACY STYLE AVAILABILITY

	Doors											Sidelites					8' Doors				8' Sidelites																										
	460	440	449	439	437	430	243	240	239	230	112	113	114	115	116	420	419	400	110	770	160	140	130	139	120	460	440	430	437	114	115	116	160	140	130												
Embarq / Signet Mahogany Series	●	●				●													●	●	●	●	●																								
Embarq / Signet Cherry Series	●	●	●			●														●	●	●	●	●														*									*
Embarq / Signet Oak Series	●	●				●														●	●	●	●	●																							
Signet Fir Series	●																			●	●	●				●																					
Embarq / Signet Knotty Alder Series	●					●														●	●	●																*	*								*
Signet Smooth Series	●	●																		●	●	●	●															●									●
Heritage Woodgrain Textured Fiberglass	●	●	●			●														●	●	●	●	●														●	●								●
Heritage Smooth Fiberglass	●	●	●			●														●	●	●	●	●														●	●	●	●	●	●	●	●	●	●
20-Gauge Woodgrain Textured Steel	●	●	●			●														●	●	○	○	○	○	○												●	○	○	○	○					○
20-Gauge Smooth Steel	●	●	●	●	●	●														●	●	○	○	○	○													●	○	○	○	○					○

○ Steel sidelites are made from 24-Gauge steel
* Embarq doors and sidelites are not available in 8' heights



 All entry systems with Privacy Glass can be ENERGY STAR® Certified depending on the glazing system you choose. This chart indicates which glazing system is required for ENERGY STAR certification, as well as availability.

Door Styles	Glazing Systems			
	TLK	TLA	DLA	DC
HALF-LITE OR LARGER 460, 449, 440, 437, 430, 439, 240, 239, 230, 112, 114, 115, 116	●	●	●	●
SMALLER THAN HALF-LITE 420, 419, 400, 243, 110	●	●	●	●

● ENERGY STAR Certified
Refer to pg. 37 for Glazing Systems information

Since Low-E glass has a slight color tint, it is recommended that sidelites are ordered with the same glazing system as the door.



† For additional door panel styles see pg. 18 (for Embarq®), pg. 22 (for Signet®), pg. 24 (for Heritage™) or pg. 26 (for Legacy™)
 § Also available in 10" width.
 * Embarq doors and sidelites are not available in 8' heights
 ‡ Cannot be mulled with Heritage Fiberglass doors in Certified Wind Load regions
 ◆ Only available with Modern Flat Window Trim.

Note - Privacy glass is available in Simulated Divided Lites (see pg. 96) and External Grids (see pg 101).



CLEAR GLASS

460DC, 770DC

Clear Glass is appropriate on every entry of your home and can still be energy efficient.

LIFETIME LIMITED WARRANTY
Includes Glass Breakage & Seal Failure

Door Styles	Glazing Systems			
	TLK	TLA	DLA	DC
HALF-LITE OR LARGER				
460, 449, 440, 439, 437, 430, 350, 240, 239, 230, 150, 112, 114, 115, 116	•	•	•	•
SMALLER THAN HALF-LITE				
420, 419, 400, 243, 110	•	•	•	•
306, 206, 131, 101, 100				•



All entry systems with Clear Glass can be ENERGY STAR® Certified depending on the glazing system you choose. This chart indicates which glazing system is required for ENERGY STAR certification, as well as availability.

• ENERGY STAR Certified

Refer to pg. 37 for Glazing Systems information

Since Low-E glass has a slight color tint, it is recommended that sidelites are ordered with the same glazing system as the door.

CLEAR GLASS STYLE AVAILABILITY

	Doors																				Sidelites					8' Doors					8' Sidelites																	
	460	440	449	439	437	430	430-F	350	243	240	239	230	150	112	113	114	115	116	420	419	400	306	206	131	110	101	100	770	160	140	139	130	120	106	460	440	430	437	150	114	115	116	160	140	130	770		
Embarq / Signet Mahogany Series	•	•	•						•											•								•	•	•	•																	
Embarq / Signet Cherry Series	•	•	•	•	•				•																			•	•	•	•								*	*		*						
Embarq / Signet Oak Series	•	•				•			•																			•	•	•	•																	
Signet Fir Series	•																		•									•	•				•															
Embarq / Signet Knotty Alder Series	•				•																							•	•								*	*				*	*					
Signet Smooth Series	•	•												•	•	•	•	•	•									•	•	•	•				•	•	•	•	•	•	•	•	•	•	•			
Heritage Textured Fiberglass	•	•	•		•	•	•	•	•	•		•	•	•	•	•	•	•	•	•								•	•	•	•				•	•						•	•	•	•			
Heritage Smooth Fiberglass	•	•	•		•	•	•	•	•	•		•	•	•	•	•	•	•	•	•								•	•	•	•				•	•						•	•	•	•			
20-Gauge Woodgrain Textured Steel	•	•	•		•	•	•	•	•	•		•	•	•	•	•	•	•	•	•								•	○	○	○	○	○		•													
20-Gauge Smooth Steel	•	•	•		•	•	•	•	•	•		•	•	•	•	•	•	•	•	•								•	○	○	○	○	○		•	•						•	•	•	•			

* Embarq doors and sidelites are not available in 8' heights
○ Steel sidelites are made from 24-Gauge steel



TRANSOMS



Clear Glass

§ Also available in 10" width.
* Embarq doors and sidelites are not available in 8' heights

† For additional door panel styles see pg. 18 (for Embarq®), pg. 22 (for Signet®), pg. 24 (for Heritage™) or pg. 26 (for Legacy™)
○ Steel sidelites are made from 24-Gauge steel
✪ Cannot be mullied with Heritage Fiberglass doors in Certified Wind Load regions
★ In Certified Wind Load region, indicated transoms must be installed in a separate opening or use approved engineering mullis
◆ Only available with Modern Flat Window Trim. Only available with 770 sidelite(s) or 160 sidelite(s) with Modern Flat Window Trim.

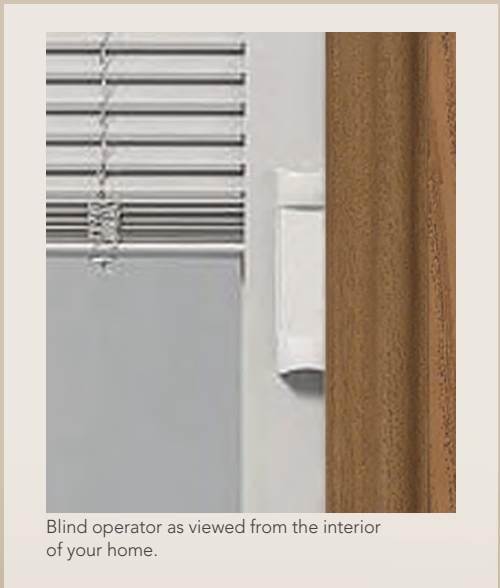

Blind operator as viewed from the interior of your home.



460BLR-IGP

WHITE INTERNAL BLINDS

Internal Blinds are constructed with sturdy white aluminum and enclosed in tempered safety glass. Easy to clean; no more dusting of blinds. Internal Blinds are suitable for entry doors, sidelites and patio doors and carry a 10-Year Warranty.

Additional Light Control - BLR styles can also be raised and lowered completely.

Internal Blinds also available with optional Low-E
 Note: 160BLD-IGT, 160BLD-IGP, 160BLD-IGC, and 160BLD cannot be raised and lowered

WHITE INTERNAL BLINDS STYLE AVAILABILITY

	Doors			Sidelites		8' Doors		
	460	440	430	230	160	130	430	440
Signet Mahogany Fiberglass	*	*	*					
Signet Cherry Fiberglass	*	*	*					•
Signet Oak Fiberglass	*	*	*					
Signet Smooth	*	*						
Signet Knotty Alder Fiberglass	*		*					•
Heritage Woodgrain Textured Fiberglass	•	•	•	•	•		•	
Heritage Smooth Fiberglass	•	•	•	•	•		•	
20-Gauge Woodgrain Textured Steel	•	•	•	•	•	•	•	
20-Gauge Smooth Steel	•	•	•	•	•	•	•	

o Steel sidelites are made from 24-Gauge steel
 * On Signet doors, blind operator will be operator pictured on page 94

All entry systems with Internal Blinds can be ENERGY STAR® Certified depending on the glazing system you choose. This chart indicates which glazing system is required for ENERGY STAR certification, as well as availability.

Door Styles	ENERGY STAR	
	DLA	DC
INTERNAL BLINDS		
With Internal Grids	•	•
INTERNAL BLINDS		
Without Grids	•	•

• ENERGY STAR Certified
 Refer to pg. 37 for Glazing Systems information

Since Low-E glass has a slight color tint, it is recommended that sidelites are ordered with the same glazing system as the door.

WITH **TRADITIONAL** (COLONIAL) INTERNAL GRIDS



WITH **PRAIRIE** INTERNAL GRIDS



WITH **COTTAGE** INTERNAL GRIDS



BLINDS **WITHOUT** INTERNAL GRIDS

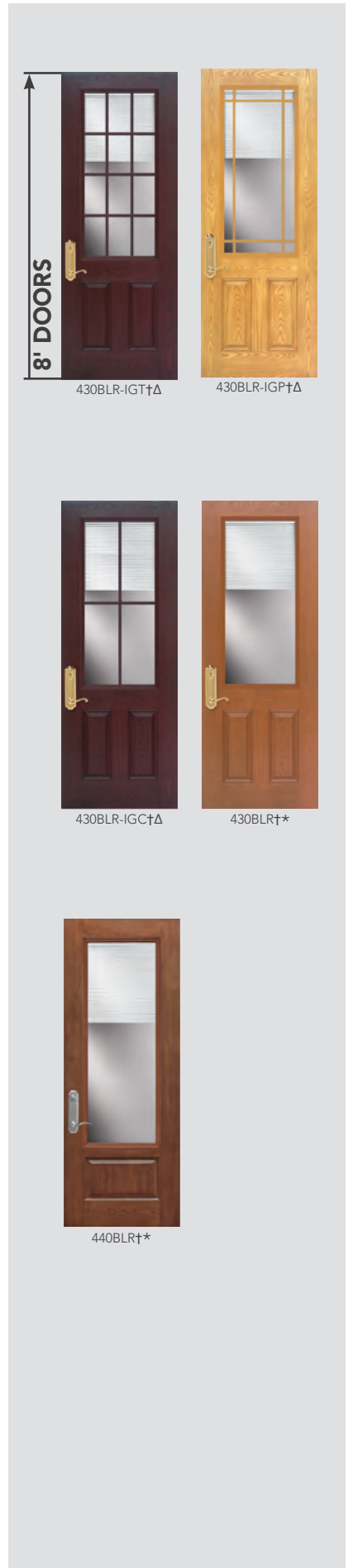

Internal Blinds

† For additional door panel styles see pg. 18 (for Embarq®), pg. 22 (for Signet®), pg. 24 (for Heritage™) or pg. 26 (for Legacy™)

Δ Not available in Signet Series

* On Signet doors, blind operator will be operator pictured on page 80

Note: 160BLD-IGT, 160BLD-IGP, 160BLD-IGC, and 160BLD cannot be raised and lowered

COLORED INTERNAL BLINDS

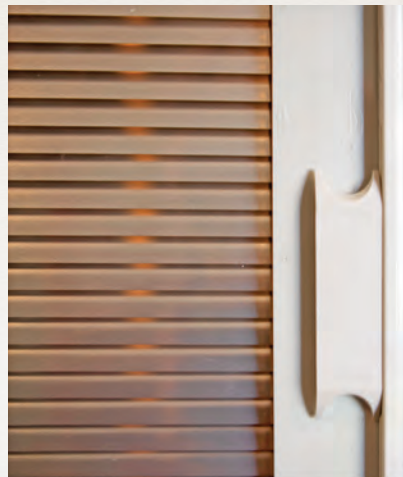

Blind operator as viewed from the interior of your home.

Internal blinds are now offered in four neutral hues to complement any room in the house. Easy to clean; no more dusting of blinds. Internal Blinds are suitable for entry doors, patio doors and windows. Offering a 10-Year Warranty.

AVAILABLE COLORS

Cream

Tan

Silver

Champagne

(require additional lead time)

**colors not available in sidelites*

COLORED INTERNAL BLINDS STYLE AVAILABILITY

	Doors			8' Doors	
	460	440	430	430	440
Signet Mahogany Fiberglass	•	•	•		
Signet Cherry Fiberglass	•	•	•		•
Signet Oak Fiberglass	•	•	•		
Signet Smooth	•	•			
Signet Knotty Alder Series	•		•	•	
Heritage Woodgrain Textured Fiberglass	•	•	•	•	
Heritage Smooth Fiberglass	•	•	•	•	
20-Gauge Woodgrain Textured Steel	•	•	•		
20-Gauge Smooth Steel	•	•	•	•	



All entry systems with Internal Blinds can be ENERGY STAR® Certified depending on the glazing system you choose. This chart indicates which glazing system is required for ENERGY STAR certification, as well as availability.

ENERGY STAR Certified
Refer to pg. 37 for Glazing Systems information

Since Low-E glass has a slight color tint, it is recommended that sidelites are ordered with the same glazing system as the door.

BLINDS **WITHOUT** INTERNAL GRIDS



460BLR

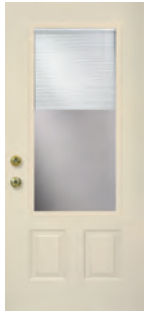

440BLR†

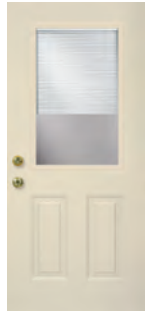

430BLR†

WITH **TRADITIONAL (COLONIAL)** INTERNAL GRIDS

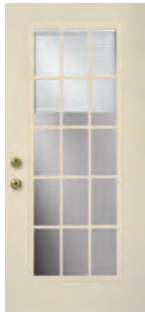

460BLR-IGTA

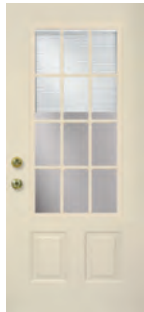

440BLR-IGT†Δ

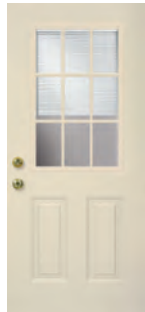

430BLR-IGT†Δ

WITH **PRAIRIE** INTERNAL GRIDS



460BLR-IGPA

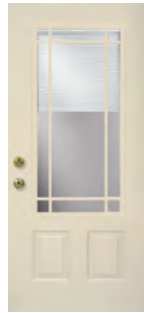

440BLR-IGP†Δ

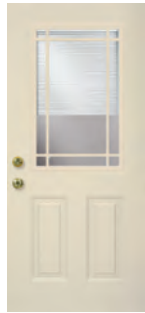

430BLR-IGP†Δ

WITH **COTTAGE** INTERNAL GRIDS

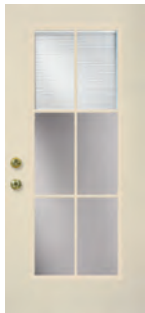

460BLR-IGCA

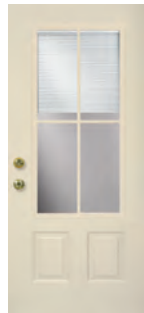

440BLR-IGC†Δ

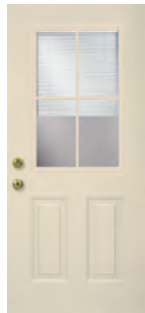

430BLR-IGC†Δ

† For additional door panel styles see pg. 18 (for Embarq®), pg. 22 (for Signet®), pg. 24 (for Heritage™) or pg. 26 (for Legacy™)
 Δ Not available in Signet Series

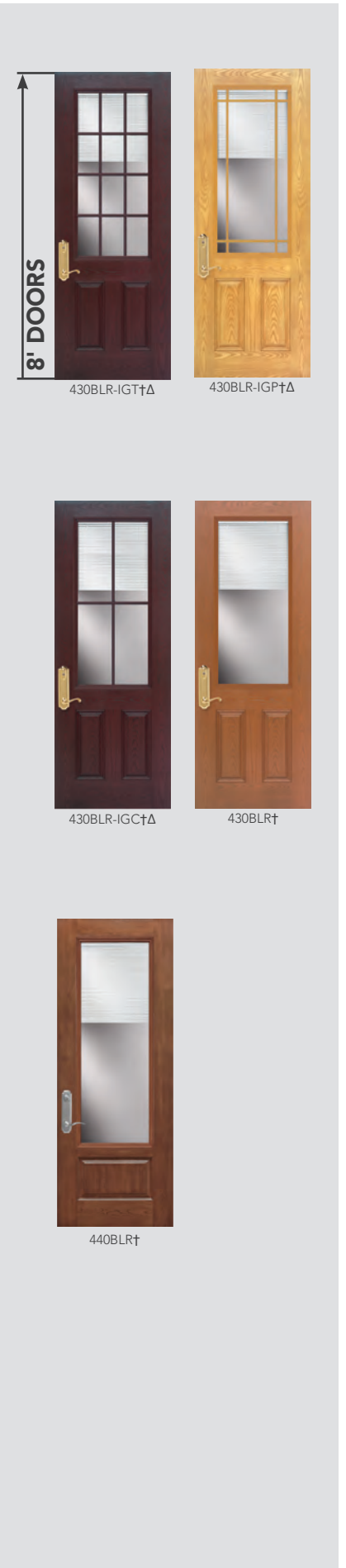

8' DOORS



430BLR-IGT†Δ

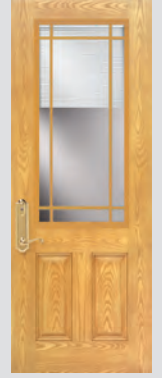

430BLR-IGP†Δ



430BLR-IGC†Δ

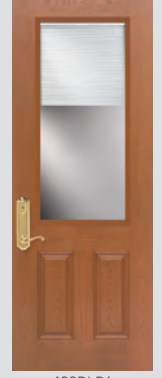

430BLR†



440BLR†

Colored Blinds

SIMULATED DIVIDED LITES

Simulated Divided Lites (SDL) are reminiscent of old world craftsmanship when separate pieces of glass were mullered together with wooden grids. We deliver that same stunning appearance through our high-tech stained fiberglass 1" wide x 1 1/32" thick grids combined with the energy efficient qualities of our ComforTech glass packages.



CRAFTSMAN
Only available for Signet Fir Series



CONTOURED
Available for all styles shown, except for Signet Fir Series

LIFETIME LIMITED WARRANTY
Includes Glass Breakage & Seal Failure



All entry systems with Simulated Divided Lites can be ENERGY STAR® Certified depending on the glazing system you choose. This chart indicates which glazing system is required for ENERGY STAR certification, as well as availability.



420DC-SDT-DS

SIMULATED DIVIDED LITES STYLE AVAILABILITY

	Doors							Sidelites				8' Doors			8' Sidelites	
	460	440	449	430	420	419	230	240	160	140	130	120	440	430	437	140
Embarq / Signet Mahogany Fiberglass	•	•		•		•			•	•	•					
Embarq / Signet Cherry Fiberglass	•	•	•	•		•			•	•	•		*			*
Embarq / Signet Oak Fiberglass	•	•		•		•			•	•	•					
Signet Fir Fiberglass	•					•			•			•				
Embarq / Signet Knotty Alder Fiberglass	•			•					•				*	*		*
Signet Smooth Fiberglass	•	•							•	•						
Heritage Woodgrain Textured Fiberglass †	•	•		•			•		•	•	•		•			
Heritage Smooth Fiberglass †	•	•					•		•	•	•		•			
20-Gauge Woodgrain Textured Steel †	•	•		•				•	•	•	•		•			
20-Gauge Smooth Steel †	•	•		•			•	•	•	•	•		•			

Door Styles	Glazing Systems				
	TLK	TLA	DLA	DC	
HALF-LITE OR LARGER 460, 440, 449, 430, 437			•	•	
SMALLER THAN HALF-LITE 420, 419			•	•	

• ENERGY STAR Certified
Refer to pg. 37 for Glazing Systems information
Since Low-E glass has a slight color tint, it is recommended that sidelites are ordered with the same glazing system as the door.

† For additional door panel styles see pg. 18 (for Embarq®), pg. 22 (for Signet®)
* Embarq doors and sidelites are not available in 8' heights
† Requires plugless trim





Note - All doors and sidelites with SDL's are available with privacy glass.
 Note - SDL's match stain or paint of door.



440DLA-IGT, 160DLA-IGT, 532DC-IGS

INTERNAL GRIDS

INTERNAL GRIDS OPTIONS

Note: Pencil Grids are not available in Prairie
Grids on some indicated doors and transoms

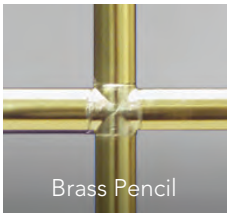

INTERNAL GRIDS STYLE AVAILABILITY

	Doors										Sidelites					8' Doors				8' Sidelites			
	460	449	440	437	430	240	230	420	419	400	770	160	140	130	120	460	440	430	437	160	140	130	770
Embarq / Signet Mahogany Series	•	•	•	•	•	•	•	•	•	•	•	•	•	•	•								
Embarq / Signet Cherry Series	•	•	•	•	•	•	•	•	•	•	•	•	•	•	•	*				*			*
Embarq / Signet Oak Series	•	•	•	•	•	•	•	•	•	•	•	•	•	•	•								
Signet Fir Series	•							•			•	•			•								
Embarq / Signet Knotty Alder Series	•										•	•					*	*		*			*
Signet Smooth Series	•	•									•	•	•	•	•	•				•			
Heritage Textured Fiberglass	•	•	•	•	•	•	•	•	•	•	•	•	•	•	•	•	•			•	•	•	•
Heritage Smooth Fiberglass	•	•	•	•	•	•	•	•	•	•	•	•	•	•	•	•	•			•	•	•	•
20-Gauge Woodgrain Textured Steel	•	•	•	•	•	•	•	•	•	•	•	o	o	o									
20-Gauge Smooth Steel	•	•	•	•	•	•	•	•	•	•	•	o	o	o		•	•			•	•	•	•



All entry systems with Internal Grids can be ENERGY STAR® Certified depending on the glazing system you choose. This chart indicates which glazing system is required for ENERGY STAR certification, as well as availability.

Door Styles	Glazing Systems		
HALF-LITE OR LARGER	TLA	DLA	DC
460, 440, 430, 240, 230	•	•	•
430, 440 Heritage Fiberglass only	•	•	•
449, 437		•	•
SMALLER THAN HALF-LITE			
420, 419, 400	•	•	•

• ENERGY STAR Certified
Refer to pg.37 for Glazing Systems information
Since Low-E glass has a slight color tint, it is recommended that sidelites are ordered with the same glazing system as the door.

* Embarq doors and sidelites are not available in 8' heights
o Steel sidelites are made from 24-Gauge steel

CONTOURED GRID COLORS AND STAINS

Snow Mist	Café Cream	Sandpiper Beige	Sandstone	Clay	Forest Green	Mountain Berry	Rustic Bronze
Tudor Brown	Coal Black†	Honey Wheat† & Light Oak†	Oak†	American Cherry† & Cherry†			

TWO-TONE CONTOURED GRIDS

Snow Mist	Snow Mist	Snow Mist	Snow Mist	Snow Mist	Snow Mist	Snow Mist
Café Cream	Sandpiper Beige	Sandstone	Forest Green	Mountain Berry	Coal Black†	Honey Wheat† & Light Oak†
Snow Mist	Snow Mist	Snow Mist	Snow Mist	Sandpiper Beige	Sandpiper Beige	Sandpiper Beige
Oak†	Almond† & Dark Oak†	American Cherry† & Cherry†	Toffee† & Traditional Cherry†	Honey Wheat† & Light Oak†	Oak†	Almond† & Dark Oak†
Sandpiper Beige	Sandpiper Beige	Sandstone	Sandstone	Sandstone	Sandstone	Sandstone
American Cherry† & Cherry†	Toffee† & Traditional Cherry†	Honey Wheat† & Light Oak†	Oak†	Almond† & Dark Oak†	American Cherry† & Cherry†	Toffee† & Traditional Cherry†

Internal Grids

TRADITIONAL (COLONIAL) INTERNAL GRIDS



PRAIRIE INTERNAL GRIDS



INTERNAL GRIDS CONT'D

COTTAGE INTERNAL GRIDS



TRANSOMS



- § Also available in 10" width.
- ** Requires an additional 4-week lead time
- † For additional door panel styles see pg. 18 (for Embarq®), pg. 22 (for Signet®), pg. 24 (for Heritage™) or pg. 26 (for Legacy™)
- o Steel sidelites are made from 24-Gauge steel
- ‡ Cannot be mulled with Heritage Fiberglass doors in Certified Wind Load regions
- * In Certified Wind Load region, indicated transoms must be installed in a separate opening or use approved engineering mulls

EXTERNAL GRIDS

LIFETIME LIMITED WARRANTY
Includes Glass Breakage & Seal Failure

460DC-EG, 160DC-EG



160DC-EG 460DC-EG 160DC-EG



130DC-EG 430DC-EG† 130DC-EG

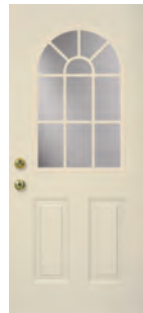

439DC-EG

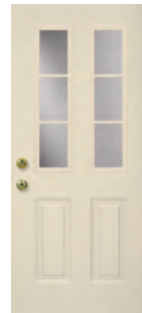

230DC-EG



410DC-EG Δ



400DC-EG†

External grids will match the door's paint or stain color.

Note: All doors with external grids (except for 410 style) are available with privacy glass.

EXTERNAL GRID STYLE AVAILABILITY

	Doors						Sidelites	
	460	430	439	230	410	400	160	130
Signet Mahogany Series								
Signet Cherry Series								
Signet Oak Series								
Signet Knotty Alder Series								
Signet Smooth Series								
Heritage Woodgrain Textured Fiberglass	•	•	•	•	•	•	•	•
Heritage Smooth Fiberglass	•	•	•	•	•	•	•	•
20-Gauge Woodgrain Textured Steel	•	•	•	•	•	•	○	○
20-Gauge Smooth Steel	•	•	•	•	•	•	○	○

† For additional door panel styles see pg. 24 (for Heritage™) or pg. 26 (for Legacy™)
 Δ Not available in 1" warm edge. Also, window trim screw plugs are not available for this door style.
 ○ Steel sidelites are made from 24-Gauge steel



All entry systems with External Grids can be ENERGY STAR® Certified depending on the glazing system you choose. This chart indicates which glazing system is required for ENERGY STAR certification, as well as availability.

Door Styles	Glazing Systems			
	TLK	TLA	DLA	DC
HALF-LITE OR LARGER				
460, 430, 439, 230	•	•	•	•
SMALLER THAN HALF-LITE				
410				•
400	•	•	•	•

• ENERGY STAR Certified
 Refer to pg. 37 for Glazing Systems information

Since Low-E glass has a slight color tint, it is recommended that sidelites are ordered with the same glazing system as the door.

STAIN FINISHES

Applied with care, by professionals. If you buy an entry system and finish it yourself, chances are it's the first door you've ever painted or stained. At ProVia®, stains are hand-applied by professional craftsmen, many who have been perfecting their work for years.



EMBARQ® & SIGNET®

EMBARQ AND SIGNET

7-STEP STAIN FINISHING SYSTEM



1. **DURAFUSE™** - Proprietary P³ Fusion Preparation Processes ensuring unprecedented finish durability
2. **HAND-APPLIED STAIN FINISH** formulated exclusively for Signet fiberglass doors
3. A layer of 2-part urethane, catalyst-hardened **CLEAR COAT WITH UV INHIBITORS** is applied
4. Clear coat is **OVEN-CURED** for lasting durability
5. The door is **HAND-SANDED**, preparing the surface for the second layer of clear coat
6. A second layer of 2-part urethane, catalyst-hardened **CLEAR COAT WITH UV INHIBITORS** is applied
7. The door is **OVEN-CURED** a second time, creating a long-lasting, durable finish

15-YEAR FINISH WARRANTY*

Embarq and Signet Fiberglass

*Warranty time period may be limited in extreme exposure applications. See warranty for details.

Always refer to our color selector for accurate color representation.



Cherry & Mahogany Stains (shown on Cherry)

Toffee

American Cherry

Chestnut

Cinnamon

Nutmeg

Hazelnut

Coffee Bean

Oak, Knotty Alder & Fir Stains (shown on Oak)

Honey Wheat

Caramel

Truffle

Ginger

Almond

Pecan

Espresso



EMBARQ® & SIGNET® GLAZED FINISHES

EMBARQ AND SIGNET

9-STEP GLAZED FINISHING SYSTEM



1. **DURAFUSE™** - Proprietary P³ Fusion Preparation Processes ensuring unprecedented finish durability
2. A 2-part urethane, catalyst-hardened **BASE COAT** (prime paint) is applied
3. Base coat is **OVEN-CURED** for lasting durability
4. **HAND-APPLIED STAIN FINISH** formulated exclusively for Signet fiberglass doors
5. A layer of 2-part urethane, catalyst-hardened **CLEAR COAT WITH UV INHIBITORS** is applied
6. Clear coat is **OVEN-CURED** for lasting durability
7. The door is **HAND-SANDED**, preparing the surface for the second layer of clear coat
8. A second layer of 2-part urethane, catalyst-hardened **CLEAR COAT WITH UV INHIBITORS** is applied
9. The door is **OVEN-CURED** a second time, creating a long-lasting, durable finish

Distinctive beauty achieved through a creative hand-applied finish giving each door a unique aged look.

Natural Leather

Winter Rain

Dutch Gray

Rustic Sage

NEW Red Velvet

NEW Windy City

NEW River Gorge

Knotty Alder, Mahogany, Fir, Cherry, Oak Glazed Finishes (Shown on Oak)

15-YEAR FINISH WARRANTY*

Embarq and Signet Fiberglass

*Warranty time period may be limited in extreme exposure applications. See warranty for details.

Always refer to our color selector for accurate color representation.

HERITAGE® & LEGACY STEEL®

LEGACY

6-STEP STAIN FINISHING SYSTEM

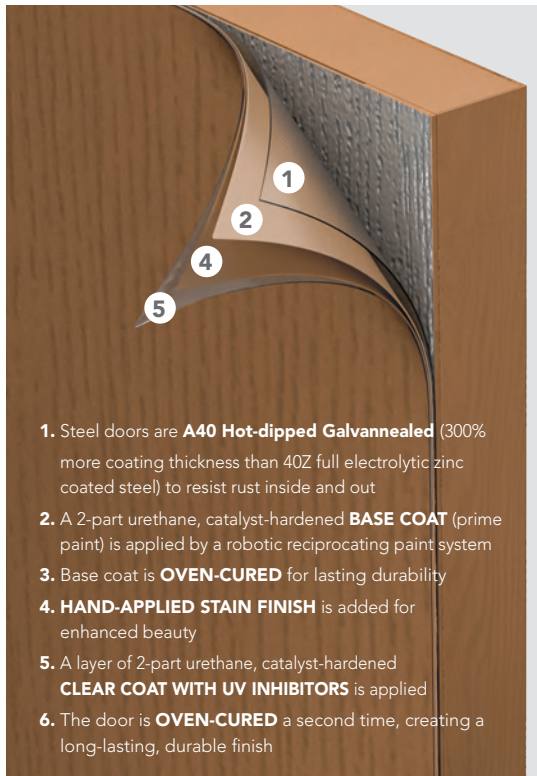

1. Steel doors are **A40 Hot-dipped Galvannealed** (300% more coating thickness than 40Z full electrolytic zinc coated steel) to resist rust inside and out
2. A 2-part urethane, catalyst-hardened **BASE COAT** (prime paint) is applied by a robotic reciprocating paint system
3. Base coat is **OVEN-CURED** for lasting durability
4. **HAND-APPLIED STAIN FINISH** is added for enhanced beauty
5. A layer of 2-part urethane, catalyst-hardened **CLEAR COAT WITH UV INHIBITORS** is applied
6. The door is **OVEN-CURED** a second time, creating a long-lasting, durable finish

HERITAGE

5-STEP STAIN FINISHING SYSTEM



1. A 2-part urethane, catalyst-hardened **BASE COAT** (prime paint) is applied by a robotic reciprocating paint system
2. Base coat is **OVEN-CURED** for lasting durability
3. **HAND-APPLIED STAIN FINISH** is added for enhanced beauty
4. A layer of 2-part urethane, catalyst-hardened **CLEAR COAT WITH UV INHIBITORS** is applied
5. The door is **OVEN-CURED** a second time, creating a long-lasting, durable finish

10-YEAR FINISH WARRANTY*

Heritage and Legacy Doors

*Warranty time period may be limited in extreme exposure applications. See warranty for details.



Heritage & Legacy Stains (shown on Oak)

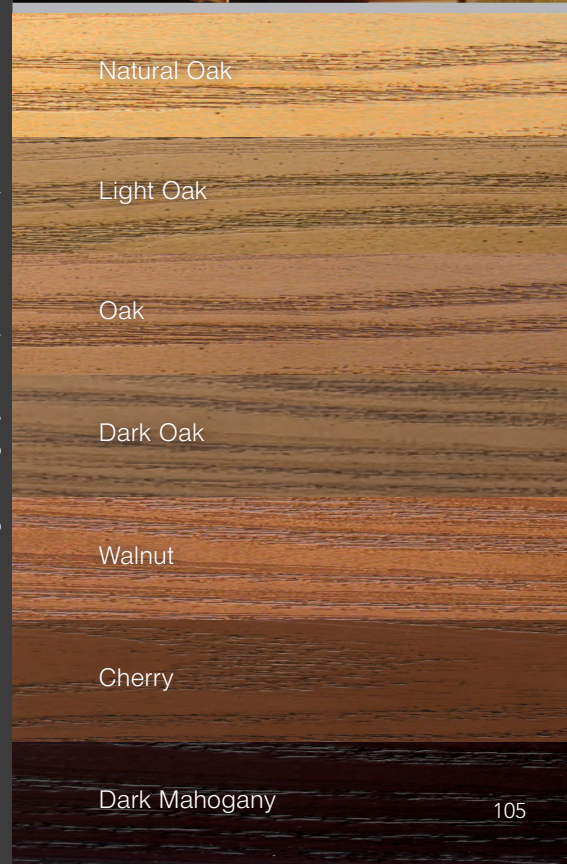

Always refer to our color selector for accurate color representation.

PAINT FINISHES

We do the finishing, so you don't have to.

You wouldn't try to paint one of these yourself, so why should it be any different when it comes to staining or painting your entry door?



EMBARQ AND SIGNET PAINTS

5-STEP PAINT FINISHING SYSTEM

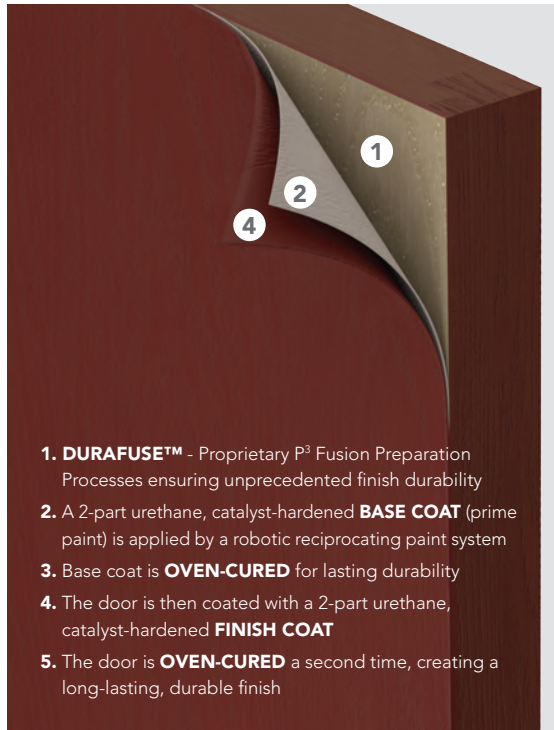

1. **DURAFUSE™** - Proprietary P³ Fusion Preparation Processes ensuring unprecedented finish durability
2. A 2-part urethane, catalyst-hardened **BASE COAT** (prime paint) is applied by a robotic reciprocating paint system
3. Base coat is **OVEN-CURED** for lasting durability
4. The door is then coated with a 2-part urethane, catalyst-hardened **FINISH COAT**
5. The door is **OVEN-CURED** a second time, creating a long-lasting, durable finish

HERITAGE PAINTS

4-STEP PAINT FINISHING SYSTEM



1. A 2-part urethane, catalyst-hardened **BASE COAT** (prime paint) is applied by a robotic reciprocating paint system
2. Base coat is **OVEN-CURED** for lasting durability
3. The door is then coated with a 2-part urethane, catalyst-hardened **FINISH COAT**
4. The door is **OVEN-CURED** a second time, creating a long-lasting, durable finish

EMBARQ®, SIGNET® HERITAGE™ & LEGACY™ STEEL

15-YEAR FINISH WARRANTY*
Embarq and Signet Fiberglass

10-YEAR FINISH WARRANTY*
Heritage and Legacy Doors

*Warranty time period may be limited in extreme exposure applications. See warranty for details.

LEGACY PAINTS

5-STEP PAINT FINISHING SYSTEM

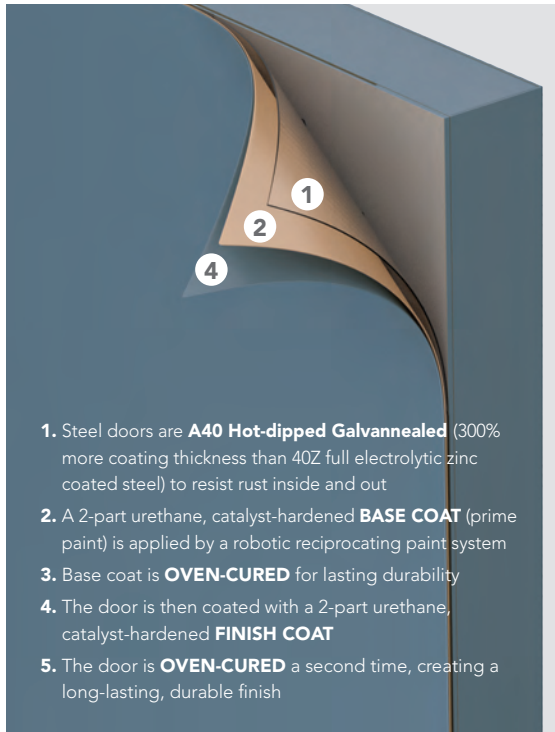

Always refer to our color selector for accurate color representation.

† Limited Colors. Matching cladding and caulking not available.

Paint Finishes

Snow Mist

Café Cream

Primrose Yellow †

Chateau

Sandpiper Beige

Sandstone

Sterling Gray

NEW Nightfall

Clay

Geneva Blue

Enzian Blue †

Forest Green

Vallis Red †

Mountain Berry

Rustic Bronze

Tudor Brown

Coal Black



NEW

TRENDING COLORS

Color trends are always changing. ProVia's color palette has been completely refreshed to give you even more paint color options for your entry doors, vinyl windows and patio doors.

All of our traditional hues have been categorized and new "trending" colors have been added, creating three very distinct color palettes to suite your taste: Natural Instincts, Freshly Picked and Stately Shades.

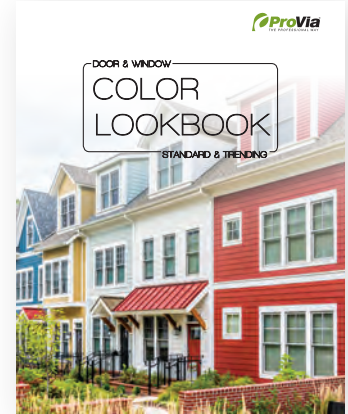

Hibiscus

Robin Egg

Plum

Avacado

Blueberry

Clover

Moss

Deep Blue

Cabernet

Goldenrod

Burnt Orange

Freshly Picked Paint Finishes

Stately Shades Paint Finishes



Always refer to our color selector for accurate color representation.

CUSTOM PAINT COLORS



Still searching for the perfect color?

Custom color-matching is also available on our Entry Doors, Aeris Windows and Patio Doors, Endure Windows and Patio Doors (exterior only).

Custom stains also available on Signet Fiberglass and Aeris Windows and Patio Doors.

Additional lead-time required.



HARDWARE

We offer a variety of designs and finishes, from angular to flowing, classic to contemporary, all with their own security features, unique functionality, and advanced technology. You'll be sure to find the features and design that will ensure your front door is the perfect complement to your new entryway.

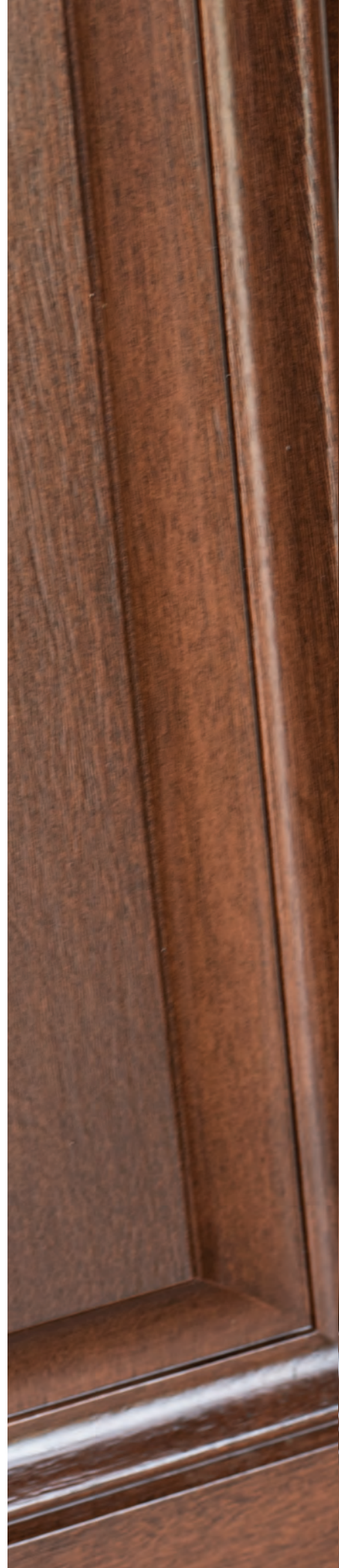



TRILENNIUM[®] MULTI-POINT

HARDWARE

The Trilennium Multi-Point locking system provides more than just security. It offers homeowners better door closure and sealing than a single point lock.

- Three 1" deadbolts latch with deadbolt throw
- Deadbolts include anti-saw hardened steel pin.
- A solid I-beam runs the full length of the lock, and increases the strength and precision of the lock.
- Latch and deadbolt release with a single downward movement.



Top and bottom latch design allows for door misalignment and $\frac{3}{16}$ " pull-in when deadbolted.

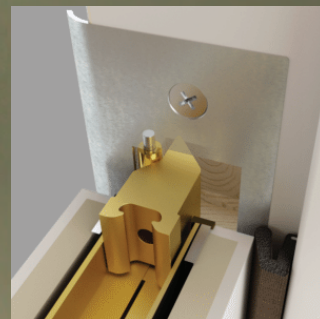
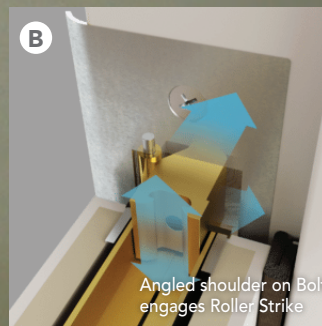

ECLIPSE



Trilennium hardware is required on all 8' Signet® and Heritage™ fiberglass doors. Optional on all other fiberglass doors.

Also available on all 20-gauge Legacy steel doors.

NOT available on Steel L-Frames

Trilennium hardware has a 10-Year warranty on materials and workmanship.

Trilennium hardware is NOT available on French Doors in Certified Wind Load or Impact Shield regions.

PINNACLE (Not available in Black Finish)



TRILENNIUM HARDWARE IS AVAILABLE IN THESE FINISHES

- Lifetime Bright Brass
- Lifetime Satin Nickel
- Lifetime Flat Bronze*
- Lifetime Black

* Flat Bronze does not coordinate with Black/Bronze accessories.

WESTCOTT (Not available in Bright Brass Finish)



Lifetime finish warranty time period is limited to five years if product is installed in an Impact Shield region.

HOPPE® MULTI-POINT

HARDWARE

Hoppe Multi-Point hardware offers the additional security of four points of latching when the door is locked, and the easy operation of one point of latching when the door is unlocked.

- Stainless Steel and other non-corrosive components.
- Anti-Back Drive prevents locking points from disengaging from the outside for added security.
- Latch Blocker on inactive systems will not allow multipoint activation until inactive system is activated.
- Lock Out Feature on interior system allows for multipoint activation from the exterior of the door by lifting handle.
- Backplate and cylinder housing are forged into one piece for improved appearance and easier installation.
- Simultaneous retraction feature enables all locking points to be retracted by pushing down on the inside handle.

**HOPPE
HARDWARE IS
AVAILABLE IN THESE
FINISHES**

Lifetime Bright Brass

Lifetime Satin Nickel

(Hoppe hardware is NOT tested for Certified Wind Load or Impact Shield regions)

*Not available on patio units.

EXTERIOR STYLES



New Orleans Contemporary Arch



New Orleans Classic Arch

INTERIOR STYLES



New Orleans Contemporary Arch



New Orleans Classic Arch

MULTI-POINT LOCKING

(Lock body faceplate is only available in stainless steel)

A

Three Point Deadbolt lock is engaged by lifting handle upward

B

Handleset latch

TO LOCK:

Step 1: Turn thumbturn ¼ turn counterclockwise

Step 2: Lift handle upward

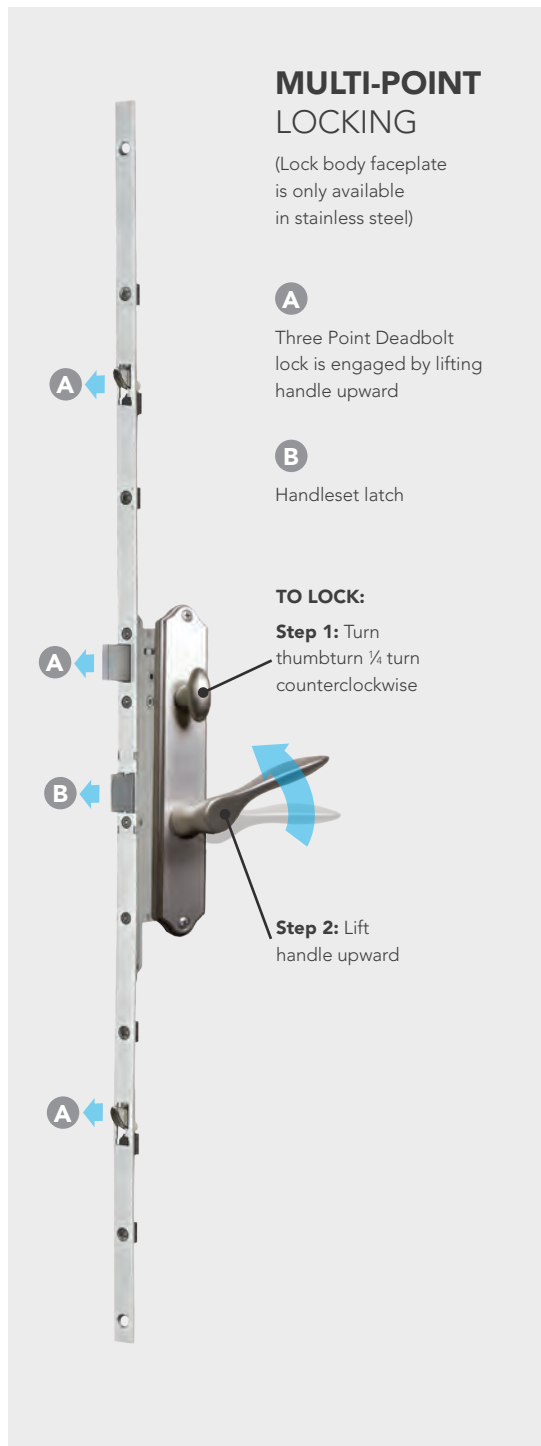



EMTEK's Mortise hardware features the added advantages and options that come with push-button controls.

- Push-button passage controls
For more passage and locking options
- Heavy-duty Forged Brass Construction - *For long lasting beauty*
- Solid Brass Nose Bolts on Latches - *For dependable use*
- Lifetime Mechanical Warranty
Our guarantee of value
- Lifetime Anti-tarnish Finish
Warranty - Beauty for life

Push button passage controls provide added security and peace of mind. When the upper button is pressed in, the mortise lock is only accessible by using a key.

To activate the Passage Function, push in the lower button. This will allow you to access the thumb latch without a key.

Note: As long as the Passage Function is NOT engaged, the door will lock automatically when latched, and will not allow entry without a key.

EMTEK[®] MORTISE

HARDWARE

EMTEK MORTISE HARDWARE IS AVAILABLE IN THESE FINISHES

Lifetime Bright Brass

Lifetime Satin Nickel

Lifetime Oil Rubbed Bronze

NEW
Lifetime Black

(EMTEK Mortise hardware is NOT tested for Certified Wind Load or Impact Shield regions)

(EMTEK Mortise hardware is only available for Signet Fiberglass and 20-gauge steel doors)

▶ See video at provia.com/provia-videos for features and operation

EXTERIOR STYLES



Craftsman*



Salem



Mills*



Albany

INTERIOR STYLES



Oval Beaded Egg (Shown on Salem)



Hammered Lever (Shown on Craftsman*)



Coventry Lever (Shown on Salem)



Square Knob (Shown on Mills*)



Cortina Lever (Shown on Albany)

EXTERIOR / INTERIOR AVAILABLE COMBINATIONS

Exterior Handles	Interior Levers and Knobs				
	Oval Egg	Square Knob	Coventry Lever	Hammered Lever	Cortina Lever
Salem	•	•	•		
Mills*	•	•	•		
Craftsman*				•	
Albany					•

* Not available in Bright Brass Finish



EMTEK's unique Interconnect Device provides the security of a locking deadbolt while providing the means for a panic-proof exit. Turning the interior knob or lever simultaneously retracts both the deadbolt and passage latches.

- Heavy-duty Forged Brass Construction - *For long lasting beauty*
- Durable Springs *To prevent lever sag*
- Threaded Brass Tubes *Solid brass nose bolts on latches*
- Lifetime Mechanical Warranty *Our guarantee of value*
- Lifetime Anti-tarnish Finish Warranty - *Beauty for life*

EMTEK HARDWARE
IS AVAILABLE IN THESE
FINISHES

- Lifetime Bright Brass
- Lifetime Satin Nickel
- Lifetime Oil Rubbed Bronze
- NEW** Lifetime Black

 Lifetime finish warranty time period is limited to five years if product is installed in an Impact Shield region.

EMTEK[®]
HARDWARE

EXTERIOR STYLES
(Single Point Lock)



Melrose



Imperial ◊



Ribbon & Reed ◊



Orleans ◊



Marietta

MODERN RECTANGULAR
(Two Point Lock)

Panic-proof exit not available in Modern Rectangular hardware



Round Knob*



Hanover Lever*

Hardware

INTERIOR STYLES

(Any interior handle can be used with any exterior handle)



Egg
(Shown on Melrose)



Egg
(Shown on Marietta)



Cortina
(Shown on Orleans)



Turino
(Shown on Imperial and Ribbon & Reed)



Round Knob*



Hanover Lever*

◊ Not available in Black

* Not available in Bright Brass finish



BRINKS® PUSH PULL ROTATE

HARDWARE

Brinks' Home Security Push Pull Rotate Knobs and Levers are the easiest, most comfortable way to open a door. With just one finger, an elbow, or your hip, you can simply push or pull your way through a door. Great if you have your hands full or free!

**BRINKS
HARDWARE IS
AVAILABLE IN THESE
FINISHES**

10-Year Satin Nickel

10-Year Aged Bronze



PUSH IT



PULL IT



ROTATE IT



EXTERIOR STYLES



Anderson with
Brynne Deadbolot*



Harper Lever with
Almarrion Deadbolt



Stafford Knob with
Almarrion Deadbolt*



INTERIOR STYLES



Harper Lever with
Brynne Deadbolt



Harper Lever with
Almarrion Deadbolt



Stafford Knob with
Almarrion Deadbolt*

EXTERIOR / INTERIOR AVAILABLE COMBINATIONS

Exterior Handles	Interior Levers and Knobs	
	Harper Lever	Stafford Knob
Anderson	•	
Harper	•	
Stafford		•

*not available for outswing doors



SCHLAGE® VINTAGE HARDWARE

Schlage Vintage hardware offers you much more than just great looks. Look to Schlage for hardware that looks great and lasts.

- Solid Cast Brass
For long lasting beauty
- Maximum Security Deadbolt
For peace of mind
- Nickel Silver Pins and Keys
For smooth, reliable operation
- Heavy Duty Springs
For durable and "droop-free" levers
- Superior Parts and Design
Tested for over 400,000 cycles of operation
- Lifetime Mechanical Warranty
Our guarantee of value
- Lifetime Anti-tarnish Finish Warranty
Beauty for life

SCHLAGE VINTAGE HARDWARE IS AVAILABLE IN THESE FINISHES

- Lifetime Bright Brass
- Lifetime Satin Nickel
- Lifetime Antique Brass
- NEW** Lifetime Black

 Lifetime finish warranty time period is limited to five years if product is installed in an Impact Shield region.

Antique Brass finish is NOT available.

EXTERIOR STYLES



INTERIOR STYLES



* Not available in Bright Brass finish



SCHLAGE® ELECTRONIC KEYPADS



SCHLAGE SENSE™ SMART DEADBOLT

The Schlage Sense Smart Deadbolt makes daily life easier and more convenient. Enter an access code on the touchscreen to unlock the door instead of searching your pockets for keys. Pairing the lock with your smartphone over Bluetooth® is as easy as pairing your phone with your car, and the free Schlage Sense app makes setting up and using the lock as simple as checking email. Share access with trusted friends and family with just a few taps – no more keeping track of spare keys.



Camelot Trim

Lifetime Satin Nickel

NEW
Lifetime Black



Century Trim

Lifetime Satin Nickel

NEW
Lifetime Black



CONTROL FROM ANYWHERE

The Schlage Sense Wi-Fi Adapter allows your smart-phone to lock/unlock your door from anywhere by creating a secure connection between your Schlage Sense Smart Deadbolt and the Wi-Fi network in your home. Set up is quick and easy, just use the free Schlage Sense app*, compatible with both iOS and Android smartphones.

*Wi-Fi Adapter is not compatible with Apple HomeKit.



HOME AUTOMATION INTEGRATIONS

Lock and unlock your door from anywhere using compatible home automation systems.

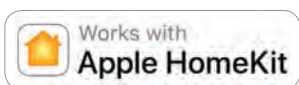

ELECTRONIC DEADBOLT

ELECTRONIC KEYPAD DEADBOLT



Exterior

Interior

ACCENT LEVER ELECTRONIC LOCKSET



Exterior

Interior

Electronic locksets and deadbolts utilize Schlage's Innovative keyless access. It's convenient and is customizable to fit your security needs.

- Deadbolt is available with any Schlage entry hardware
- 9-volt battery included
- Lighted keypad
- Up to 19 user codes
- Easy to add or delete codes
- Lifetime Mechanical and 3-Year Electronics Warranty

AVAILABLE FINISHES

Lifetime Bright Brass

Lifetime Satin Nickel

Lifetime Antique Brass

TOUCH KEYPAD ELECTRONIC KEYLESS DEADBOLT



Exterior

Interior

ACCENT LEVER TOUCH KEYPAD ELECTRONIC KEYLESS LOCKSET



Exterior

Interior

- Fingerprint-resistant
- Works in the rain and when you're wearing gloves
- 100% pick-proof
- Sleek without sacrificing strength
- 2-year battery life with a 9V battery backup
- Illumination when you need it, on both the numbers and the lever
- Enhanced Security
- 100% bump-proof
- Graded Best in Residential Security, Durability, and Finish

AVAILABLE FINISH

NEW Lifetime Black



Lifetime finish warranty time period is limited to five years if product is installed in an Impact Shield region.

SCHLAGE® CLASSIC HARDWARE

Schlage Classic hardware can fill your needs when you desire something understated, yet beautiful and lasting. Choose from an assortment of finishes.

SCHLAGE CLASSIC HARDWARE FINISHES

Lifetime Bright Brass

Lifetime Satin Nickel

Lifetime Antique Brass

NEW
Lifetime Black



Lifetime finish warranty time period is limited to five years if product is installed in an Impact Shield region.

Antique Brass finish is NOT available.

SCHLAGE CLASSIC DOOR LOCKSETS AND DEADBOLTS



Accent/Addison
Keyed Lockset*



Accent Keyed
Lockset



Exterior Interior
Georgian Key in
Knob Lockset



Flair Keyed
Lockset



Latitude Lever with Century
Trim Keyed Lockset §



Latitude Lever with Collins
Trim Keyed Lockset ‡



Addison Trim *



Exterior Interior
Maximum Security
Double Key
1" Deadbolt ◊



Interior Only 1-Sided
Thumbturn 1" Deadbolt ◊
(Only available in 20-Gauge
Steel or Signet Fiberglass)



Century Trim §



Thumbturn 1"
Deadbolts

◊ Interior Only 1-Sided Thumbturn Deadbolts on any door which is used for egress may be a safety hazard in times of emergency. Double Key Deadbolts on any door which is used for egress are a safety hazard in times of emergency.

* Not available in Bright Brass finish

‡ Only available in Satin Nickel finish

§ Only available in Satin Nickel and Aged Bronze finish

SCHLAGE PASSAGE LATCHES



Accent/Addison
Passage Latch*



Accent
Passage Latch



Latitude Lever with
Century Trim §



Latitude Lever
with Collins Trim ‡



Flair
Passage Latch



Georgian
Passage Latch

OPTIONAL ACCESSORIES

Sometimes the smallest things make the biggest difference. Our accessories add a lot to the look of your entry system.



Colonial Door Knocker



Classic Door Knocker



Classic Door Knocker/Viewer



Mail Slot or Magazine Slot*
(NOT tested for Certified Wind Load or Impact Shield regions)
(Doors with Mail Slot or Magazine Slot are not ENERGY STAR® certified)



1/8" Peepsite**



Kick Plate

OPTIONAL DECORATIVE HINGES NOT tested for Impact Shield regions.

Also available in Satin Nickel & Oil Rubbed Bronze (Inswing only)



Steeple



Ball

ACCESSORIES FINISH AVAILABILITY 5-Year Mechanical Warranty

Accessories	Lifetime Finish			5-Year Finish		No Finish Warranty	Impact Shield 5-Year Finish
	Bright Brass	Satin Nickel	Black/Bronze	Bright Brass	Antique Brass	Oil Rubbed Bronze	Bright Brass, Satin Nickel & Black/Bronze
Colonial Door Knocker	•	•				•	• (N/A Black/Bronze)
Classic Door Knocker/Viewer	•	•	•	•	•		•
Classic Door Knocker	•	•	•	•	•		•
Magazine Slot*	•	•	•	•	•		
Mail Slot*	•	•	•	•	•		
Kick Plate	•	•	•	•	•		•

* Mail slot and magazine slot are not available on 003C, 006C, 008P, 009, 420-DS, 420-2P, 420-3P, 110, 243, 440, 240, 449, 460, & 350 door styles. Additionally, magazine slots are also not available on 002C-449 & 003 door styles.

** Peepsite available in Bright Brass, Chrome (recommended for use with Satin Nickel hardware finish) and Aged/Antique (recommended for use with Aged Bronze or Antique Brass hardware finish) with 5-year finish warranty.



OPTIONS

002CP-437, 160BRC

The Hinge Straps, Clavos and Speakeasy are options that can give your entryway an old world look. Combine these options with our Signet® Knotty Alder Series to achieve a rustic or antique style. Hinge Straps, Clavos and Speakeasy are constructed of durable flat black aluminum.

HINGE STRAPS Available on all door styles shown on opposite page



Available as an Impact Shield product.



CLAVOS Available only on door styles shown with planks on opposite page
(002CP-449, 002CP-437, 8' 002CP-449 and 8' 002CP-437)



Available as an Impact Shield product.



SPEAKEASY Available on all door styles shown below except for 8' 002C-437 and 8' 002CP-437

NOT tested for Certified Wind Load or Impact Shield regions. (Doors with Speakeasy are not ENERGY STAR® certified.)
 ProVia® does not recommend entry doors with Speakeasy applications in the Northern climate zone. We also recognize some of the North-Central climate zone areas are not suitable for this application as well. We recommend this application to be used only in the South-Central and Southern climate zones. Speakeasy applications carry a 5-year limited warranty. See price book for more details.



Exterior



Interior

IRON DOOR



Exterior



Interior

SEEDY GLASS DOOR
(single pane)

FAUX SPEAKEASY

Enjoy the decorative look of a speakeasy without impeding the energy efficiency of the entry door. Available on all door styles shown below.



SIGNET® & EMBARQ® FIBERGLASS DOOR STYLES

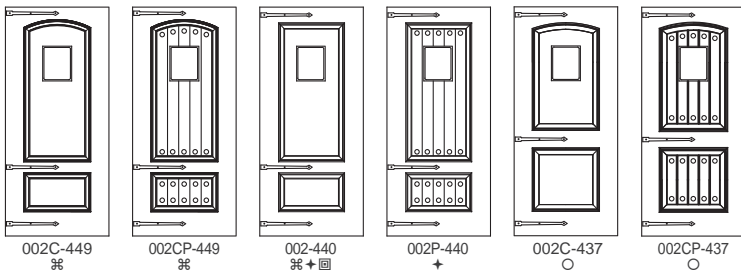

- ⌘ Signet/Embarq Cherry
- + Signet/Embarq Oak
- Signet/Embarq Knotty Alder
- ▣ Signet Smooth

8' SIGNET FIBERGLASS DOORS

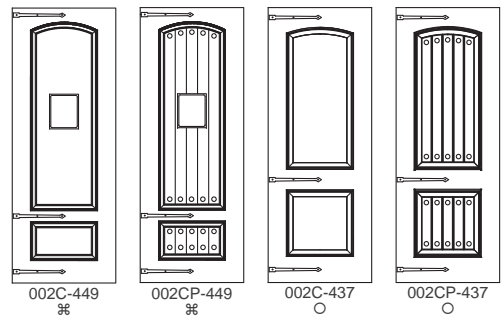

OPTIONS



PlexiDor® PET DOOR

(NOT available in Certified Wind Load or Impact Shield regions)
(Doors with Pet Door are not ENERGY STAR® certified)

Factory Installed - Available on Flush Doors Only

- Shatter resistant saloon-styled door panels provide durability and insulation
- Thermo-pane panels lined with high density weather seal for maximum energy efficiency
- Available in White, Silver, and Bronze frames
- Available on the following styles: 001, 430DC-F, 430VNT-F, 430DC-EG-F, 430DC-IGT-F, 100DC, 101DC, 131DC & 306DC

Medium: 9" x 12" opening for pets up to 40 lbs.
Large: 11¾" x 16" opening for pets up to 100 lbs.
X-Large: 15¾" x 23⅝" opening for pets up to 220 lbs.



FREEDOM® PET DOOR

(NOT available in Certified Wind Load or Impact Shield regions)
(Doors with Pet Door are not ENERGY STAR® certified)

Factory Installed - Available on Flush Doors Only

- Solid aluminum construction with locking panel
- Soft single flap for tight weather seal
- Antique White mitered aluminum frame
- Available on the following styles: 001, 430DC-F, 430VNT-F, 430DC-EG-F, 430DC-IGT-F, 100DC, 101DC, 131DC & 306DC
- Also available on storm doors. See pg. 156.

Medium: 8¼" x 12¼" opening for pets up to 40 lbs.
Large: 10¼" x 16¼" opening for pets up to 100 lbs.
X-Large: 13¾" x 23¾" opening for pets up to 220 lbs.

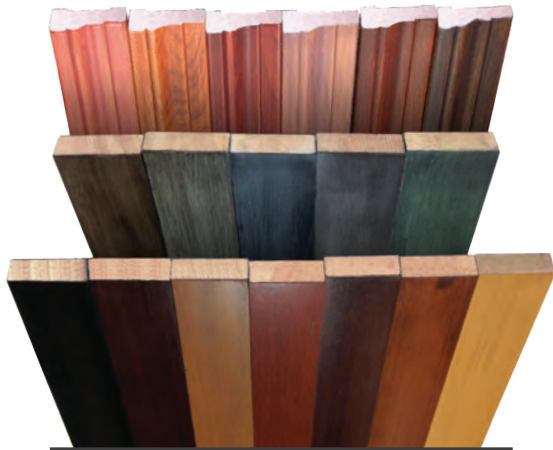

CASING

Put the finishing touch on the inside of your entryway with our beautiful interior casing. Available in Cherry, Mahogany, Fir, Oak or Poplar wood.



2½" Modern



2½" Colonial



3½" Colonial

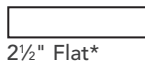

2½" Flat*

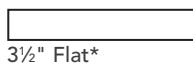

3½" Flat*

Available for any door configuration including transoms.

Signet® stains are available on Cherry, Mahogany, Oak or Fir casing, and Heritage™ and Legacy™ stains are available on Oak or Poplar casing. Paint and glazed finishes are available on Poplar casing.

Custom Casing

Don't see a casing style you need? We have a custom casing program that can meet your needs. Contact your dealer for additional information on our Custom Casing program.

* Only available in Fir and Poplar



3" Wide Brickmold

Choose from our standard 2" brickmold or our wider 3" brickmold.

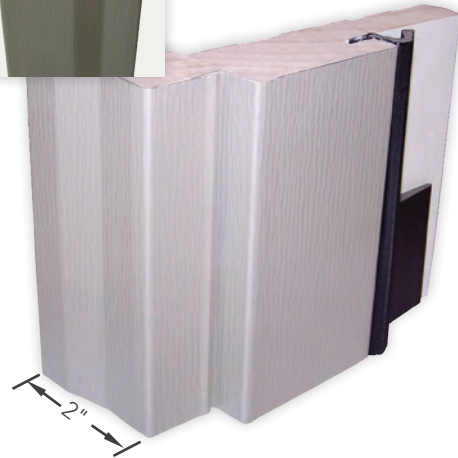

ALUMINUM PRE-FIT CLADDING

Cladding is worth the small investment. You can add cladding to any FrameSaver® or PermaTech™ Composite Frame.

- Protective
- Maintenance-free
- Stays beautiful
- Factory applied

TEXTURED CLADDING COLORS

Snow Mist	Café Cream	Chateau
Sandpiper Beige	Sandstone	Sterling Gray
Clay	Geneva Blue	Forest Green
Mountain Berry	Rustic Bronze	Tudor Brown
Coal Black	Oak	Cherry
new Nightfall		

TUFTEX SMOOTH CLADDING COLORS

Aluminum trim coil with mar-resistant smooth finish.

Snow Mist	Sandpiper Beige	Sandstone ◊	Classic Bronze*
-----------	-----------------	-------------	-----------------

◊ Smooth Sandstone cladding is a close match, but not an exact match to Sandstone paint color.

* Smooth Classic Bronze cladding does not match Rustic Bronze cladding color or Rustic Bronze paint color.

HINGED PATIO DOORS

Hinged Patio Doors are swinging patio door systems available in 2 or 3-lite units and constructed of the same solid quality Signet® and Heritage™ Fiberglass, and Legacy™ Woodgrain Textured or Smooth Steel doors as our entry door units.



IMPACT SHIELD AVAILABLE
See pgs. 160 for available door styles

Designer Patio Doors with Heritage Fiberglass are NOT available in Certified Wind Load regions.



460BLR-IGP

PATIO DOOR STANDARD FEATURES



A keyed Schlage® flair handle with a Maximum Security thumbturn deadbolt is included. Choose from bright brass, antique brass, satin nickel or aged bronze finish. Optional Lifetime finishes available.



The lock area is reinforced with a 20-gauge steel security plate for added strength.



Spring-loaded latch system automatically engages upon closing. Latch also includes interior locking feature. BetterVue® fiberglass screen mesh is standard. Heavy-duty fiberglass, aluminum or SeeVue® stainless steel screen is optional.



Suspended by ball bearing rollers this top-hung heavy-duty aluminum screen frame reduces binding, creating effortless operation. Screen frames are available in all 16 paint colors.

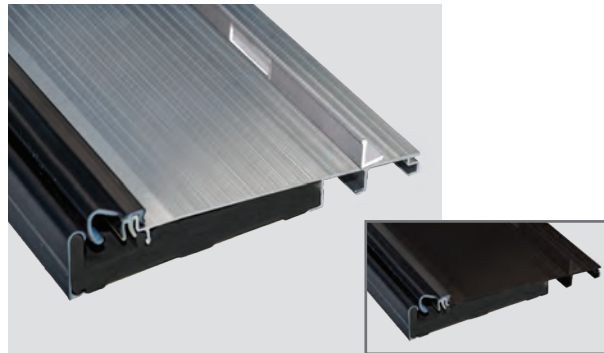

Z-AC™ Threshold with an auto-adjusting riser. Available in Mill or Anodized Bronze Finish

 Thresholds for Impact Shield rated Hinged Patio Doors have an oak-like riser and do not have composite base material

DOOR SWING

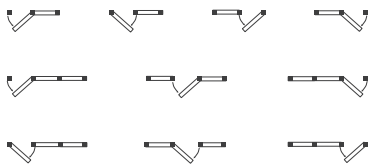



OPTIONS

Custom Widths and Heights - Need a little more height or a little less width? We are pleased to offer customized patio door widths and heights in 1/8" increments.

Door Swing - (Doors viewed from above. Inswing only.)

Finishes - Patio doors are available in all finishes shown on pages 21-29.

STANDARD SIZING INFORMATION

Patio Unit Sizing	Downsized (Standard) Patio Doors					Full Size Patio Doors				
	Patio Width	Unit Size	Rough Opening	Brickmold to Brickmold*	Patio Height	Patio Width	Unit Size	Rough Opening	Brickmold to Brickmold*	Patio Height
	60"	59 ¹ / ₁₆ "	60 ³ / ₁₆ "	61 ¹⁵ / ₁₆ "	Rough Opening Height 79 ³ / ₈ "	60"	61 ¹ / ₈ "	62 ³ / ₈ "	64 ¹ / ₈ "	Rough Opening Height 82"
	64"	63 ¹ / ₁₆ "	64 ³ / ₁₆ "	65 ¹⁵ / ₁₆ "		64"	65 ⁵ / ₈ "	66 ³ / ₈ "	68 ¹ / ₈ "	
	68"	67 ¹ / ₁₆ "	68 ³ / ₁₆ "	69 ¹⁵ / ₁₆ "		68"	69 ³ / ₈ "	70 ³ / ₈ "	72 ¹ / ₈ "	
	72"	71 ¹ / ₁₆ "	72 ³ / ₁₆ "	73 ¹⁵ / ₁₆ "	Unit Height Not Including Brickmold 79 ³ / ₈ "	72"	73 ³ / ₈ "	74 ³ / ₈ "	76 ¹ / ₈ "	Unit Height Not Including Brickmold 81 ⁵ / ₈ "
	90"	88 ¹ / ₁₆ "	89 ⁵ / ₁₆ "	91 ¹ / ₁₆ "	Unit Height Including Brickmold* 80 ⁵ / ₈ "	90"	91 ³ / ₄ "	92 ¹ / ₂ "	94 ¹ / ₄ "	Unit Height Including Brickmold* 82 ⁷ / ₈ "
	96"	94 ¹ / ₁₆ "	95 ⁵ / ₁₆ "	97 ¹ / ₁₆ "		96"	97 ³ / ₄ "	98 ¹ / ₂ "	100 ¹ / ₄ "	
	102"	100 ¹ / ₁₆ "	101 ⁵ / ₁₆ "	103 ¹ / ₁₆ "		102"	103 ³ / ₄ "	104 ¹ / ₂ "	106 ¹ / ₄ "	
	108"	106 ¹ / ₁₆ "	107 ⁵ / ₁₆ "	109 ¹ / ₁₆ "		108"	109 ³ / ₄ "	110 ¹ / ₂ "	112 ¹ / ₄ "	

* Optional Aluminum Frame Cladding will increase brickmold to brickmold width by 1/4" and height by 1/8". Not all sizes available in all door types.

VINYL SLIDING PATIO DOORS

Vinyl Sliding Patio Doors are tested against the most stringent industry standards for air and water infiltration, wind load resistance, ease of operation, forced entry and much more. This means you'll have lower heating and air-conditioning costs, easier cleaning, low maintenance and increased comfort.



IMPACT SHIELD AVAILABLE
See pgs. 167 for available door styles

LIFETIME LIMITED WARRANTY
Includes Glass Breakage & Seal Failure





All Vinyl Sliding Patio Doors are ENERGY STAR® Certified



Suspended by ball bearing rollers this top-hung heavy-duty aluminum screen frame with BetterVue® fiberglass mesh reduces binding, creating effortless operation.

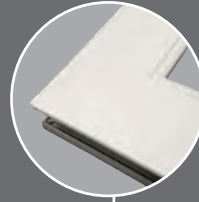

New welding technology gives patio door corners a cleaner look. Standard on all laminated Endure™ patio doors with the option to upgrade on white, beige and sandstone.



Strong, multi-chamber profiles and 4 7/8" frame depth offer greater thermal efficiency and increased sound abatement. (Endure Patio Door frames have Neopor® insulation).



Spring-loaded latch system automatically engages upon closing. Latch also includes interior locking feature. BetterVue® fiberglass mesh is standard; heavy-duty fiberglass, stainless steel or aluminum mesh is optional.



AccuVent™ has a clean, sophisticated look with an ergonomic finger-tipped lever design for ease of use. AccuVent is standard for Endure, optional for Aspect and has a Lifetime Warranty.

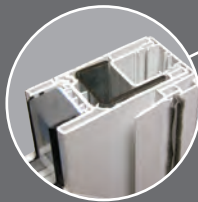

Galvanized steel reinforced panels ensure rigidity and stable operation.



Sill is reinforced with galvanized steel. Pair that with our patented water draining system, and the results are an efficient and durable base for our patio door.



Fixed and mobile panel rails meet and interlock perfectly, making removal from the outside virtually impossible. Lower sill design provides safer entry and exit.



The foot lock adds peace of mind when you want to leave the door open for ventilation yet keep would-be intruders out. Standard for Aspect, optional for Endure.



Patented sliding system features four adjustable 1" wheels per operating panel to ensure smooth, easy and quiet operation.

OPTIONS

INTERNAL GRIDS



Internal Grids
Triple Glazed Glass



Internal Grids
Double Glazed Glass



Contoured



Flat



V-Groove

SAMPLE GRID PATTERNS

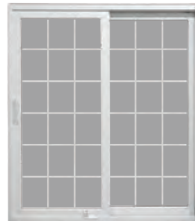

Colonial 2V5H



Cottage 1V2H



Double Prairie



Cottage TS-2V1H



Single Prairie

INTERNAL BLINDS (NOT tested for Impact Shield regions)



Exterior



Interior

- Ultra-Privacy edge channel design keeps out light and prying eyes
- Blinds tilt, raise and lower using the convenient fingertip adjustment slides
- Easy to clean; no more dusting of blinds
- Internal Blinds are available in silver, champagne, white, cream or tan.
- 10-Year Limited Warranty
- Available in standard and custom sizes (see price list for availability)
- Available in 1, 2, 3 and 4 lite models



Blinds with Low-E on surface
2 and 4 are ENERGY STAR®
certified nationwide

CONFIGURATION Available in 2, 3 or 4-panel configurations in both standard and custom sizes

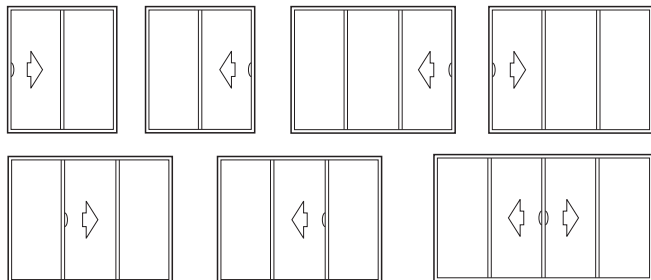

Only available in 2-panel configuration in Certified Wind Load regions. Sidelites and transoms must be installed in a separate opening or use approved engineering mulls.

Only available in 2-panel configuration in Impact Shield regions. Sidelites and transoms are NOT available.



Fixed sidelites



Transoms

PATIO DOOR & INTERNAL GRID COLORS

Exterior	White	White	White	White
Interior	White	Classic *Oak	Dark *Oak	Traditional *Cherry
Beige	White*	Classic *Oak	Dark *Oak	Traditional *Cherry
Sandstone	White*	Classic *Oak	Dark *Oak	Traditional *Cherry
Classic Bronze	Classic *Oak	Dark *Oak	Traditional *Cherry	

* Laminated Vinyl
Please refer to our color selector for accurate color representation.

HARDWARE Standard Mortise Hardware

Our Standard Mortise Hardware is available in White, Beige, Sandstone and Black.



Optional Mortise Hardware (with keylock)

Schlage® C Keyway on all keyed locking handles allow single key entry for the entire house (Also optional for Aspect)

Our Optional Mortise Hardware with keylock is available in White, Beige, Sandstone, Black, Aged Bronze, Antique Brass and Bright Brass.



OTHER OPTIONS

- Flat and Contoured Internal Grids
- Internal Blinds (white, cream, tan silver, champagne)
- Inspirations™ Art Glass
- ComforTech™ DLA-UV (standard), DLA-UV-HC, TLA-UV and TLK-UV. **NOT tested for Impact Shield regions.**
- Tinted glass: Gray, Bronze, Green or Blue
- Privacy glass (Obsure Pebble, Chinchilla, Taffeta, Waterfall, Gluechip)
- Single and Double Prairie beveled glass
- 8' wide units can be ordered assembled or knock-down. For Impact Shield regions, units less than 6' (width) x 6'8" (height) can be ordered assembled or knock-down. All larger units will be ordered knock-down.

PATIO DOOR & INTERNAL GRID COLORS

White	Beige	Sandstone
-------	-------	-----------

Please refer to our color selector for accurate color representation

HARDWARE Standard Mortise Hardware

Our Standard Mortise Hardware is available in White, Beige, Sandstone and Black.



Optional Mortise Hardware (with keylock)



White, Beige, Sandstone, Black



Bright Brass
Satin Nickel
Flat Bronze*

*Flat Bronze coordinates (but is not an exact match) with Aged Bronze accessories.

OTHER OPTIONS

- Flat and Contoured Internal Grids
- Internal Blinds (White)
- ComforTech™ DLA (standard), DLA-HC, TLA and TLK. **NOT tested for Impact Shield regions.**
- Tinted glass: Gray, Bronze, Green or Blue
- Privacy glass (Obsure Pebble, Chinchilla, Taffeta, Waterfall, Gluechip)
- Single and Double Prairie beveled glass
- 8' wide units can be ordered assembled or knock-down. For Impact Shield regions, units less than 6' (width) x 6'8" (height) can be ordered assembled or knock-down. All larger units will be ordered knock-down.

Please refer to the Endure and Aspect Patio Door Brochures for more information.

STORM DOORS

Every storm door is individually customized to the highest standards in the residential market for homeowners who appreciate impeccable, uncompromising quality.

All ProVia Storm Doors are available for use in the Impact Shield regions. While storm doors help protect your entry door from the elements, they are NOT wind-borne debris tested, and therefore are NOT considered an Impact Shield Product.



389 Self-Storing



Durable, oven-baked polyester finishes are backed by a Lifetime Warranty for lasting beauty and low maintenance.

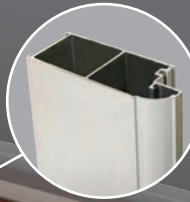

Extruded aluminum frame adds beauty to your door by virtue of the rounded cove molding along the glass edge of the extrusion.



You'll appreciate the finished look of our **color matched aluminum installation screw covers**.



All our storm doors are constructed with **tempered safety glass**.

Non-operable sashes are secured by our **color matched polycarbonate clips** or an **internal sash lock system**. Varies by model.



Smooth function is essential. That's why we include a **quality door closer** in every storm door package. Varies by model.

Each door features **quality hardware** that adds beauty and functionality to your new storm door. Varies by model.

Our air release system features a continuous closing action without the delayed rebound action of previous generation closers.



Corrosion-proof corner gussets enhance the structural integrity of the door.



Our **bottom expander with sweep** allows for a beautiful custom-fit to any entry. Varies by model.

Storm Doors

STORM DOOR DETAILS

The details are the small things that set our storm doors apart from the competition. A lot of small things add up to a big difference.

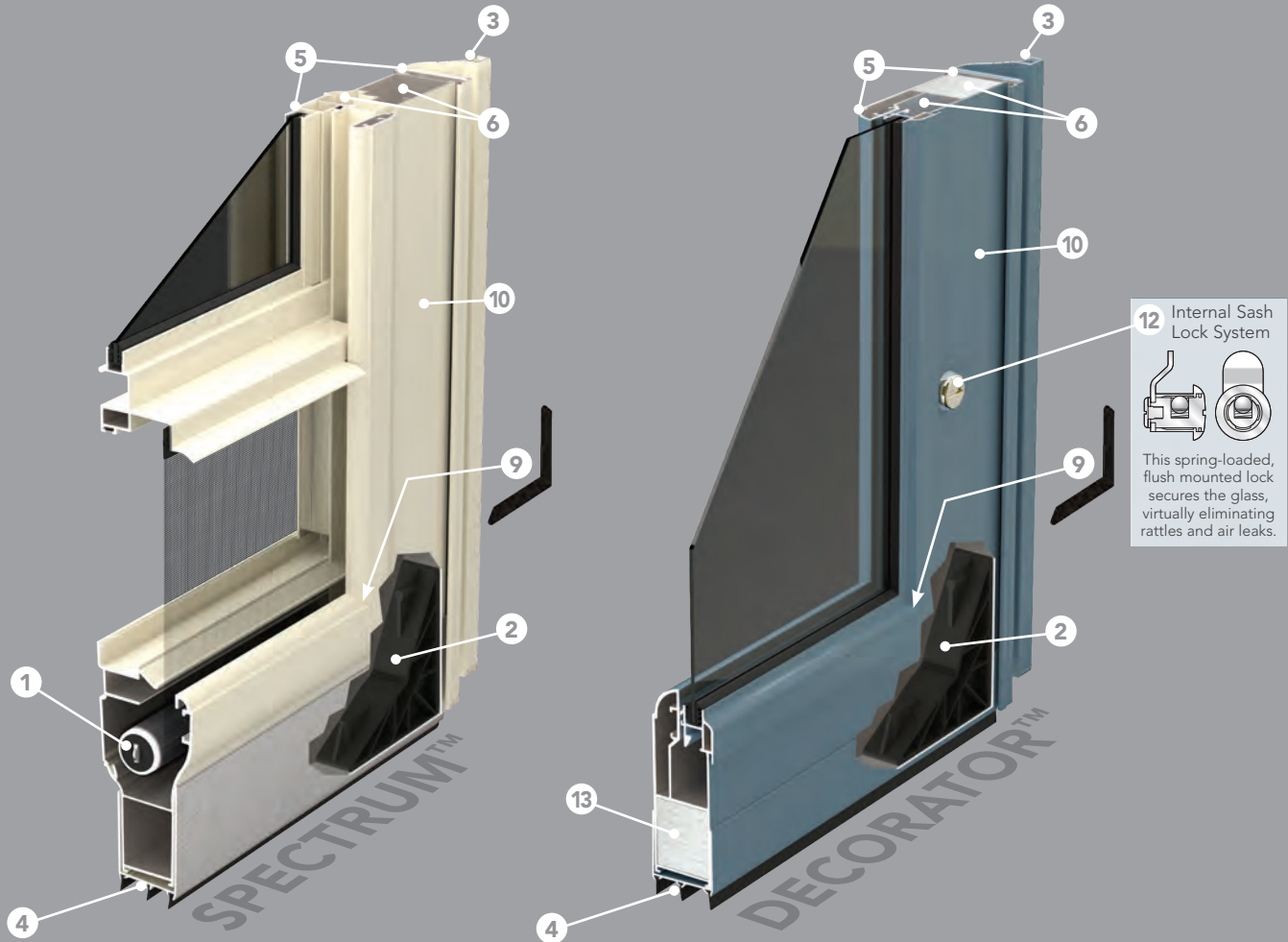

CONSTRUCTION

	Spectrum	Decorator	Deluxe	DuraGuard	Superview
1 InVent™ Retractable Screen System	●				
2 Outside corners are secured to corrosion-proof gussets, for structural integrity	●	●	●	●	●
3 Color matched aluminum installation screw covers enhance the appearance of your door	●	●	●	●	●
4 The bottom sweep eliminates drafts	Triple	Triple	Double	Double	Single
5 The sculptured frame adds durability	1¼" x 4¾"	1¼" x 4"	1¼" x 3½"	1¼" x 3½"	1¼" x 2½"
6 Multi-hollow construction provides greater strength and security than standard storm doors	●	●	●	●	
7 The reinforced aluminum kick panel adds durability	●		●	●	
8 The aluminum kick panel resists rust and adds strength	●		●	●	●
9 Corner keys provide added support to the inside of the door frame	●	●	●	●	
10 Aluminum wall thickness up to 20% thicker than industry standard	●	●	●	●	
11 The .023 gauge stainless steel screen offers extra security and protection (12 x 12 mesh)				●	
12 Non-operable sash/screen secured by internal lock system or color matched polycarbonate clips		Internal Lock	Clips	Clips	Clips
13 Standard insulated frame core to help reduce air movement	Optional	●	Optional	Optional	
14 Screen included	●	Optional	●	●	●

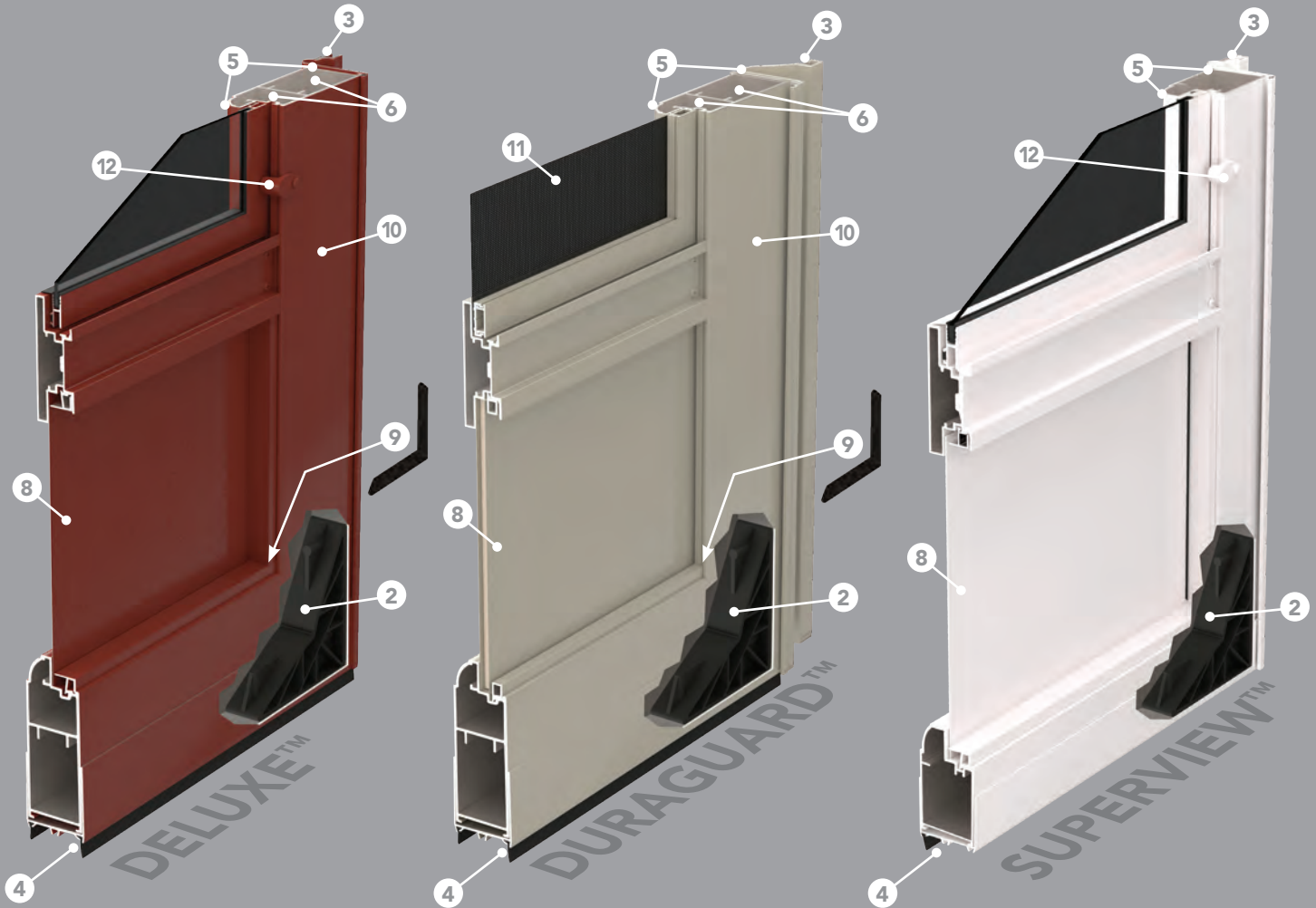

STORM DOOR PAINT FINISHING SYSTEM

Our paint process is computer controlled, ensuring professional quality every time. Paint is electrostatically applied with a vertical hydraulic reciprocator using a turbo disc that atomizes the paint particles for better coverage of contoured extrusions.

LIFETIME FINISH WARRANTY

For all Storm Doors

STORM DOOR PAINT COLORS

Always refer to our color selector for accurate color representation.

Snow Mist	Café Cream	Primrose Yellow †	Chateau	Sandpiper Beige	Sandstone	Clay	Sterling Gray	NEW Nightfall
Geneva Blue	Enzian Blue †	Forest Green	Vallis Red †	Mountain Berry	Rustic Bronze	Tudor Brown	Coal Black	

† Limited Colors. Available on entry doors and storm doors. Matching cladding and caulking not available.



291 Full View

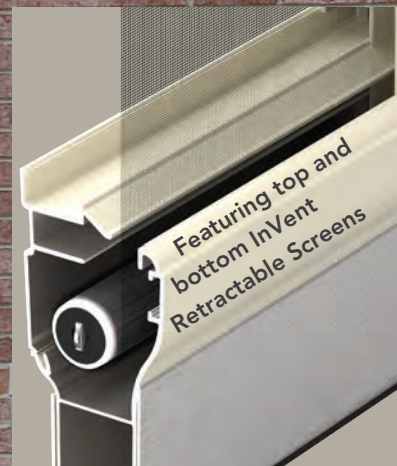

Featuring top and bottom InVent Retractable Screens

SPECTRUM™

STORM DOORS

Spectrum Series storm doors bring you smooth functionality, beauty and durability. Our exclusive top and bottom InVent™ retractable screen system allows you more venting options than ever.

SPECTRUM STORM DOORS INCLUDE:

- Two InVent retractable screens
- Triple seal bottom sweep
- 1¼" x 4¾" wide sculptured frame

LIFETIME LIMITED WARRANTY

Includes Glass Breakage

STANDARD HARDWARE & ACCESSORIES



Satin Nickel Sierra solid brass Mortise Hardware ◊

NOT recommended or warranted for coastal applications

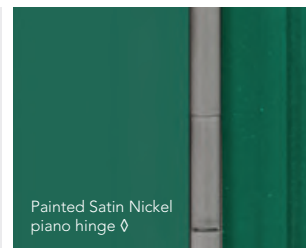

Painted Satin Nickel piano hinge ◊



1½" Satin Nickel bottom expander ◊



Color-matched dual closers



295-B Full View Double Prairie with Beveled Glass and Brass Inlay ◊
 295-Z Full View Double Prairie with Beveled Glass and Zinc Inlay
 295 Full View Double Prairie with Beveled Glass
 298-B Three-Quarter View with Beveled Glass and Brass Inlay ◊
 298-Z Three-Quarter View with Beveled Glass and Zinc Inlay
 298-VG Three-Quarter View with Beveled Glass



291 Full View (Inspirations Glass available)
 298 Three-Quarter View (Inspirations Glass available)
 279-C Colonial Half-Lite ‡
 279 Flush Half-Lite ‡
 292 Provincial Half-Lite ‡
 293 Crossbuck Half-Lite ‡
 291SH Full View (Only one InVent top screen and fixed bottom sash)



298SH Three-Quarter View (Only one InVent top screen and fixed bottom sash)
 274-CSH Colonial Half-Lite (Only one InVent top screen and fixed bottom sash) * ‡
 274SH Half-Lite (Only one InVent top screen and fixed bottom sash) * ‡



298-AME Americana (Timberland)
 298-AZT Aztec (Coral Reef)
 298-TUL Tulips (Vineyard)

INSPIRATIONS™ ART GLASS

Ask to see our Inspirations Art Glass brochure for our complete selection of designs, color palettes and style availability.

- * When top sash opens, it passes in front of kick panel
- ◊ Bright Brass hardware, anodized brass piano hinge and brass-look bottom expander are standard on Spectrum storm doors with brass caming.
- ‡ Available in 8' height

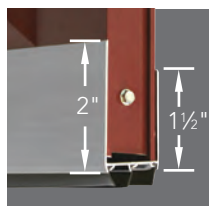

Note: The bottom expander on the Spectrum storm door is 2" on the exterior and 1 1/2" on the interior to accommodate the frame profile



For French Storm Door information refer to the ProVia® Door Price List



595 Full View Double Prairie with Beveled Glass

DECORATOR™

STORM DOORS

Decorator Series provides a stylish, fresh look to accent your entry. Select one of the distinct styles from our Decorator Series storm doors.

DECORATOR STORM DOORS INCLUDE:

- Triple seal bottom sweep
- 1 1/4" x 4" wide sculptured frame

LIFETIME LIMITED WARRANTY
Includes Glass Breakage

STANDARD HARDWARE & ACCESSORIES



Bright Brass Windsor Hardware ◊

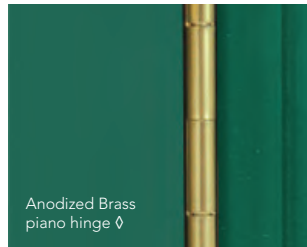

Anodized Brass piano hinge ◊

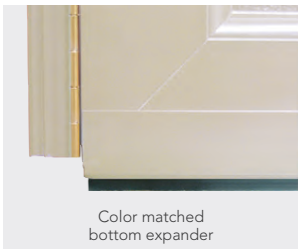

Color matched bottom expander



Color-matched dual closers



591 Full View Archway with Beveled Glass



591-B Full View Archway with Beveled Glass & Brass Inlay



591-Z Full View Archway with Beveled Glass & Zinc Inlay ◊ ‡



595 Full View Double Prairie with Beveled Glass



#595-B Full View Double Prairie with Beveled Glass & Brass Inlay



#595-Z Full View Double Prairie with Beveled Glass & Zinc Inlay ◊ ‡



590 Full View ‡



590-WES Westin ◊ ‡



590-VIN Vintage (Timberland) ◊ ‡

INSPIRATIONS™ ART GLASS

Ask to see our Inspirations™ Art Glass brochure for our complete selection of designs, color palettes and style availability.



This spring-loaded, flush mounted lock secures the glass, virtually eliminating rattles and air leaks. Only available in Zinc finish

Acrylic is required (instead of tempered glass) for custom size storm doors where the sash size is greater than 20 square feet or the sash weigh is greater than 36 pounds. entryLINK will automatically change the glass selection to Acrylic based on these limits.

Optional full screen with horizontal stabilizer bar available for all Decorator doors.
◊ Satin Nickel hardware, and painted Satin Nickel piano hinge are standard on Decorator storm doors with zinc coming or Inspirations Art Glass.

‡ Available in 8' height

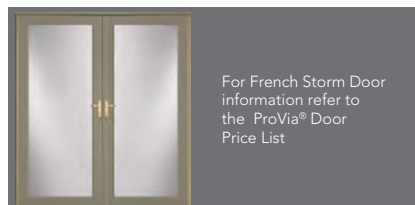

For French Storm Door information refer to the ProVia® Door Price List



DELUXE™

STORM DOORS

Deluxe Series is the answer whether you're looking for additional light, ventilation or protection from the elements. You'll find the exact style you're looking for in our Deluxe Series of storm doors.

DELUXE STORM DOORS INCLUDE:

- Double seal bottom sweep
- 1¼" x 3⅝" wide sculptured frame
- BetterVue® Fiberglass Screen

LIFETIME LIMITED WARRANTY

Includes Glass Breakage

STANDARD HARDWARE & ACCESSORIES

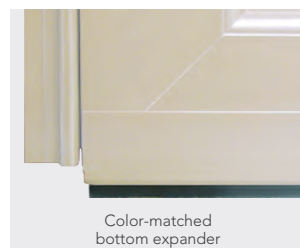
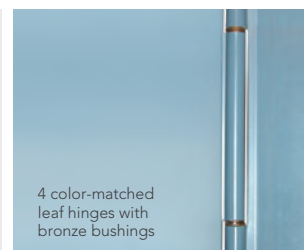



385 Full View Double Prairie with Beveled Glass (Includes screen*) ‡



382 Full View with Beveled Glass (Includes screen*)



397 Full View (Includes screen*)



391 Full View Divided Lite (Includes top screen) ‡



396-V One-Lite with fixed .023 gauge stainless steel screen ventilated bottom & removable sash (Includes top screen*) ‡ (Inspirations Glass available)



396 One-Lite (Includes screen*) (Inspirations Glass available) ‡



399-M Modern Self-Storing (Includes full screen) ‡
Dent-Resistant Aluminum kick panel



399 Self-Storing (Includes full screen*) ‡



398-M Modern Hi-Lite (Includes top screen) ‡
Dent-Resistant Aluminum kick panel



398 Hi-Lite (Includes top screen) ‡



389-M Modern Self-Storing (Includes full screen*) ‡
Dent-Resistant Aluminum kick panel



389 Self-Storing (Includes full screen*) ‡



379-C Colonial Self-Storing (Includes full screen) ‡
Dent-Resistant Aluminum kick panel



379 Self-Storing (Includes full screen) ‡
Reinforced Aluminum kick panel



392 Provincial Self-Storing (Includes full screen) ‡
Reinforced Aluminum kick panel



394 Provincial (Includes screen) ‡
Reinforced Aluminum kick panel



393 Crossback Self-Storing (Includes full screen) ‡
Reinforced Aluminum kick panel



395 Crossback (Includes screen) ‡
Reinforced Aluminum kick panel



374-C Colonial Half-Lite (Includes screen) ‡
Dent-Resistant Aluminum kick panel



374 Flush Half-Lite (Includes screen) ‡
Reinforced Aluminum kick panel



397-VIN Vintage (Timberland)

Acrylic is required (instead of tempered glass) for custom size storm doors where the sash size is greater than 20 square feet or the sash weigh is greater than 36 pounds. entryLINK will automatically change the glass selection to Acrylic based on these limits.

* Full and One-Lite screens have horizontal stabilizer bar

‡ Available in 8' height

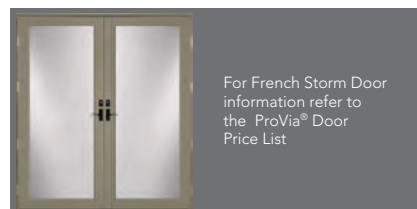

INSPIRATIONS™ ART GLASS

Ask to see our Inspirations Art Glass brochure for our complete selection of designs, color palettes and style availability.

Deluxe Storm Doors

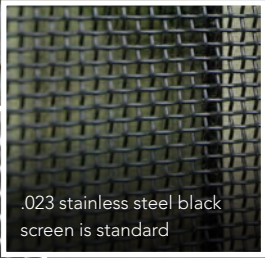

.023 stainless steel black screen is standard



Also available in white



Note: White screen can appear to have different levels of transparency depending on the lighting and background.

097 Screen Door

DURAGUARD™

STORM DOORS

DuraGuard is exactly what you need if you're concerned about keeping your small children and pets safely inside. Select one of our doors with heavy-duty, non-removable stainless steel screening.

DURAGUARD STORM DOORS INCLUDE:

- Non-removable .023 stainless steel screen (only available on DuraGuard models)
- Double seal bottom sweep
- 1¼" x 3⅝" wide sculptured frame

LIFETIME LIMITED WARRANTY

Includes Glass Breakage

STANDARD HARDWARE & ACCESSORIES



Black Contemporary Curve Hardware

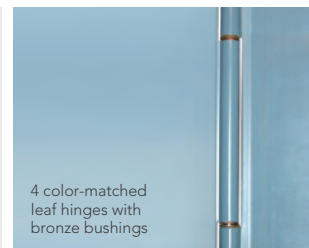

4 color-matched leaf hinges with bronze bushings

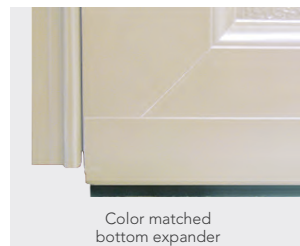

Color matched bottom expander



Heavy-duty color-matched closers



097 Screen Door ‡
097-G with removable
glass insert



096 Screen Door ‡
096-G with removable
glass insert ‡



096-GV With ventilated
bottom and removable
top and bottom sashes ‡



099 Self-Storing
Sash & Screen



099-M
Modern Self-Storing
Sash & Screen



089 Self-Storing
Sash & Screen



089-M
Modern Self-Storing
Sash & Screen



074 Flush Half Lite
(Removable sash) ‡



074-C
Colonial Half Lite
(Removable sash) ‡



094 Provincial Half Lite
(Removable sash) ‡



095 Crossback Half Lite
(Removable sash) ‡



079 Self-Storing
‡



079-C Colonial
Self-Storing ‡



092 Provincial
Self-Storing ‡



093 Crossback
Self-Storing ‡

Acrylic is required (instead of tempered glass) for custom size storm doors where the sash size is greater than 20 square feet or the sash weigh is greater than 36 pounds. entryLINK will automatically change the glass selection to Acrylic based on these limits.

‡ Available in 8' height

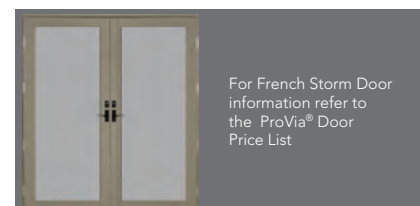



SUPERVIEW™

STORM DOORS

Superview offers a selection of storm doors constructed for style and value in one complete package.

SUPERVIEW STORM DOORS INCLUDE:

- Single seal bottom sweep
- 1¼" x 2½" wide sculptured frame
- BetterVue® Fiberglass Screen

LIFETIME LIMITED WARRANTY
Includes Glass Breakage

STANDARD HARDWARE & ACCESSORIES



Black Pull Handle
(Also available in white)



4 color-matched leaf hinges with bronze bushings

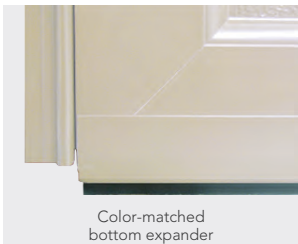

Color-matched bottom expander

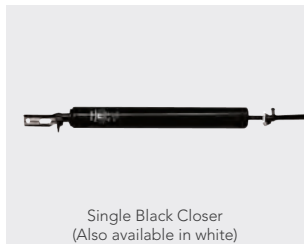

Single Black Closer
(Also available in white)



897 Full View
(Includes screen*)



896 One-Lite
(Includes screen*)



898 Hi-Lite
(Includes top screen)



899 Self-Storing
(Includes bottom screen)



895 Crossback
(Includes screen)

Superview storm doors are available in the following colors



Always refer to our color selector for accurate color representation.

* Full and One-Lite screens have horizontal stabilizer bar



MORTISE HARDWARE

Mortise Hardware adds a special touch to your storm door with a solid brass handleset to suit your style. Our Multi-Point Mortise hardware conveniently allows you to use the same key for your storm door and your ProVia® entry door.

Satin Nickel Sierra Mortise Hardware

MULTI-POINT

SIERRA (SOLID BRASS MORTISE)



VENICE (SOLID BRASS MORTISE)



AVAILABLE FINISHES

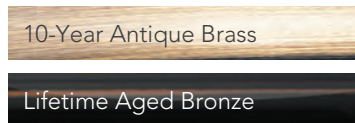
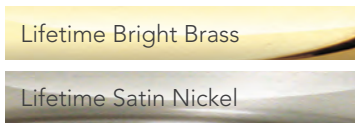

Our Mortise hardware features a multi-point locking system for added strength and security not found on typical consumer-grade storm door hardware.

Requires a factory handleset prep and is not available on expander door.

HARDWARE FINISH AVAILABILITY

HARDWARE AVAILABILITY

Exterior Handle Styles	LIFETIME Bright Brass	LIFETIME Satin Nickel	LIFETIME Aged Bronze	10-Year Finish Antique Brass	Spectrum™	Decorator™	Deluxe™	DuraGuard™	Superview™
Sierra	●	●	●	●	Standard*	■	■	■	
Venice	●	●	●	●	■	■	■	■	

● Interior handle finish matches exterior handle

■ Available as an option

*Not recommended or warranted for coastal applications. Windsor Lever on pg.154 is standard for Impact Shield regions

SINGLE-POINT

WESTGATE



Westgate Interior

Optional Single-Point Mortise hardware, offering enhanced security, durability and style over standard surface mounted hardware.

AVAILABLE FINISHES

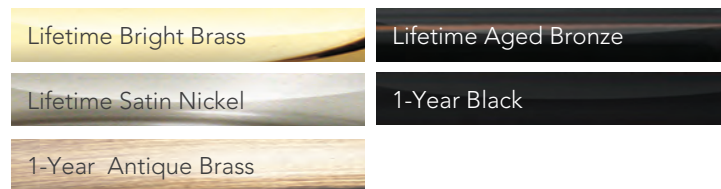

CAMBRIDGE



Cambridge Interior



Not available to be Keyed to entry door.

Requires a factory handleset prep and is not available on expander door.

AVAILABLE FINISHES

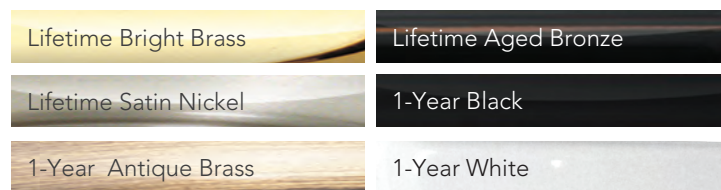

Hardware	FINISH AVAILABILITY						AVAILABILITY				
	LIFETIME Bright Brass	LIFETIME Satin Nickel	LIFETIME Aged Bronze	1-Year Antique Brass	1-Year White	1-Year Black	Spectrum™	Decorator™	Deluxe™	DuraGuard™	Superview™
Cambridge	●	●	●	●	●	●	■	■	■	■	
Westgate	●	●	●	●		●	■	■	■	■	

● Interior handle finish matches exterior handle

■ Available as an option

*Not recommended or warranted for coastal applications. Windsor Lever on pg.154 is standard for Impact Shield regions



HARDWARE

With both elegance and durability, our hardware makes the right first impression. Choose from our wide selection of solid hardware to customize your storm door.

Antique Brass Windsor Hardware

WINDSOR



Windsor Interior

TOWNSEND



Townsend Interior

AVAILABLE FINISHES



Hardware Finish Availability	Hardware Availability										
	LIFETIME Bright Brass	LIFETIME Satin Nickel	LIFETIME Aged Bronze	1-Year Antique Brass	1-Year White	1-Year Black	Spectrum™	Decorator™	Deluxe™	DuraGuard™	Superview™
Windsor	●	●	●	●	●	●	■	Standard	■	■	■*
Townsend	●	●	●	●	●	●	■	■	■	■	■*

● Interior handle finish matches exterior handle

■ Available as an option

† Standard color is black

* Not available on Superview Model 899

CONTEMPORARY CURVE LEVER

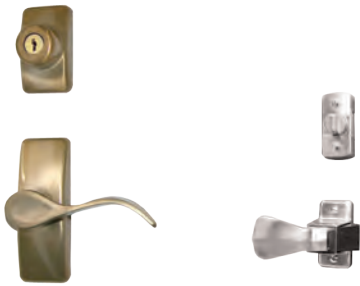

Contemporary Curve Interior

AVAILABLE FINISHES

Contemporary Curve

Lifetime Bright Brass

Lifetime Satin Nickel

1-Year Antique Brass

Lifetime Aged Bronze

1-Year Black

1-Year White

PUSH BUTTON



201

202/192

Push Button Interior
(201 & 202)

(Interior handle finish
matches exterior handle)

AVAILABLE FINISHES

Push Button/Pull Handle

1-Year Black

1-Year White

PULL HANDLE



181

182

Interior Handle

Push Button Interior (192)
and Pull Handle Interior

(Interior handle finish
matches exterior handle)

HARDWARE FINISH AVAILABILITY

HARDWARE AVAILABILITY

Exterior Handle Styles	LIFETIME Bright Brass	LIFETIME Satin Nickel	LIFETIME Aged Bronze	1-Year Antique Brass	1-Year White	1-Year Black	Spectrum™	Decorator™	Deluxe™	DuraGuard™	Superview™
Contemporary Curve	●	●	●	●	●	●	■	■	Standard †	Standard †	■*
Push Button (DH201 & DH202)					●	●			■	■	■*
Push Button (DH192)						●					■
Pull Handle					●	●					Standard †

● Interior handle finish matches exterior handle

■ Available as an option

† Standard color is black

* Not available on Superview Model 899

ACCESSORIES



FREEDOM PET DOOR

Factory Installed - Available on Flush Doors Only

- Solid aluminum construction with locking panel
- Soft single flap for tight weather seal
- White mitered aluminum frame
- Also available on entry doors. See page 130.
- Also available on additional storm door styles.
- Only available with heavy-duty closer, Pet Door N/A with dual closers

Medium

8¼" x 12¼" opening for pets up to 40 lbs.

Large

10¼" x 16¼" opening for pets up to 100 lbs.

X-Large

13¾" x 23¾" opening for pets up to 220 lbs.



#279 Flush Half-Lite
with Pet Door Option



#079 Self-Storing
with mail slot option

MAGAZINE & MAIL SLOT

Lifetime Bright Brass, Lifetime Satin Nickel and Lifetime Aged Bronze magazine and mail slots are available on 074, 079, 279, 374 and 379.

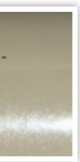

Anodized Brass piano hinge and bottom expander

PIANO HINGE & BOTTOM EXPANDER



Painted Satin Nickel piano hinge and bottom expander



Painted Aged Bronze piano hinge and bottom expander

Our **air release system** features a continuous closing action without the delayed rebound action of previous generation closers.

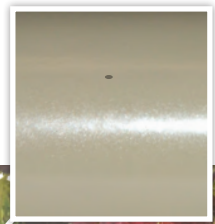

EASY-SET CLOSER

Just a slight push on the cap and it'll stay open. Push door open further and it releases. Color matched to door.



IMPACT SHIELD PRODUCTS

FLORIDA

Impact Shield Products are designed to protect your family and home against the harshest storms and deter burglars. All entry systems and patio doors in this Impact Shield Products section are wind-borne debris resistant and approved by the State of Florida. floridabuilding.org

- Impact Shield
- Certified Wind Load
- High-Velocity Hurricane Zones
(ProVia products have not been tested for use in High-Velocity Hurricane Zones)

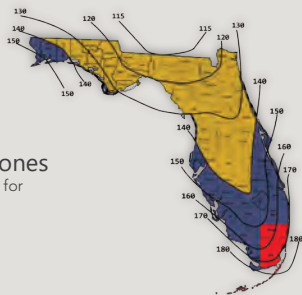

TEXAS

Impact Shield Products have been tested for the Designated Catastrophe Areas in Texas. Refer to provia.com/certification for a complete listing of approved products.

Designated Catastrophe Areas

TEXAS FIRST TIER COASTAL COUNTIES & CERTAIN AREAS LOCATED IN HARRIS COUNTY EAST OF HWY 146

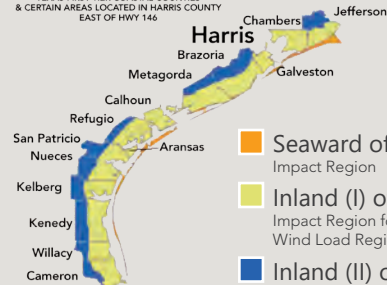

- Seaward of Intracoastal Canal Impact Region
- Inland (I) of Intracoastal Canal Impact Region for All Glazed Product
Wind Load Region for All Opaque Product
- Inland (II) of Intracoastal Canal Wind Load Region

We're constantly testing new Certified Wind Load and Impact Shield products. For the latest information visit: provia.com/certification

All of our Impact Shield Products feature ComforTech™ laminated glass.

ComforTech™ TLK-C
ComforTech™ TLK-UV-C

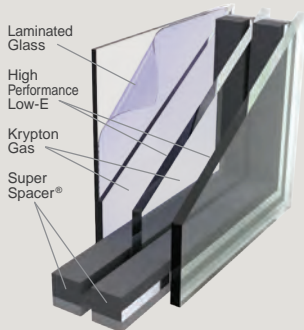

■ ■ ■ ■ ■ ■ ■ ■ ■ ■
R-Value of 9

ComforTech™ TLA-C
ComforTech™ TLA-UV-C

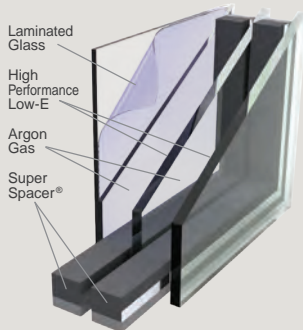

■ ■ ■ ■ ■ ■ ■ ■ ■ ■
R-Value of 6

ComforTech™ DLA-C
ComforTech™ DLA-UV-C

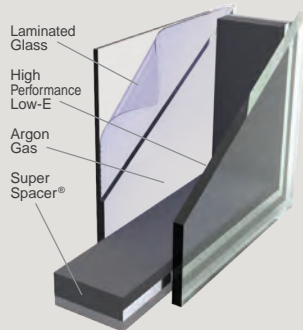

■ ■ ■ ■ ■ ■ ■ ■ ■ ■
R-Value of 4

ComforTech™ DC-C

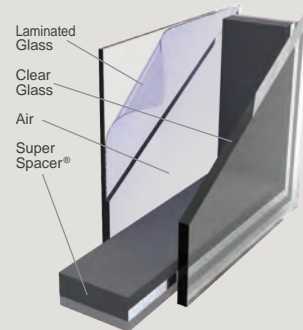

■ ■ ■ ■ ■ ■ ■ ■ ■ ■
R-Value of 2

R-Value reflects properties of the glass only. Center of glass calculations are based upon software from Lawrence Berkeley National Laboratory.



Entry Systems ComforTech™ Glass Package	R-Value	Solar Heat Gain Coefficient (SHGC)	Visible Light	UV Transmittance
INSULATED GLASS UNIT				
1" ComforTech DC-C	2	0.72	80%	59%
1" ComforTech DLA-C	4	0.39	71%	20%
1" ComforTech DLA-UV-C	4	0.27	63%	5.9%
1½" ComforTech TLA-C	5	0.33	54%	6.9%
1½" ComforTech TLA-UV-C	5	0.23	45%	0.7%
1½" ComforTech TLK-C	6	0.33	54%	6.9%
1½" ComforTech TLK-UV-C	6	0.23	45%	0.7%

LIFETIME

— LIMITED WARRANTY —

Includes Glass Breakage
and Seal Failure



Look for indicated
ENERGY STAR® Certified
Impact Shield Products.

ENTRY DOOR AND DESIGNER™ PATIO DOOR IMPACT SHIELD FEATURES

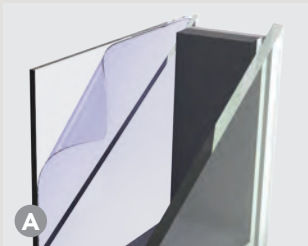

All glass for Impact Shield Products is laminated to provide protection against wind-borne debris.



Heavy-duty stainless steel hinges resist corrosion and are standard in wind-borne debris regions.



Smooth Steel



Textured Steel

Aluminum window trim of our own exclusive design provides ultimate durability in the harshest of elements. Textured Steel doors have hand-stained smooth aluminum window trim.

VINYL SLIDING PATIO DOOR IMPACT SHIELD FEATURES

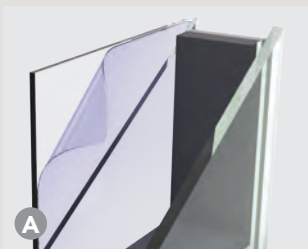

All glass for Impact Shield Products is laminated to provide protection against wind-borne debris.



Additional heavy aluminum interlock on center stile adds durability and strength.



STORM DOORS

All ProVia® storm doors are available for use in the Impact Shield regions. While storm doors help protect your entry door from the elements, they are NOT wind-borne debris tested, and therefore are NOT considered an Impact Shield Product.



PAGE NUMBERS REFERENCE PROVIA IMPACT SHIELD PRICE BOOK

ESSENCE

612/613ESZ ‡ † pg. 30



160ESZ pg. 14 460ESZ pg. 12 160ESZ pg. 14



770ESZ§ † pg. 16 440ESZ† pg. 10 770ESZ§ † pg. 16

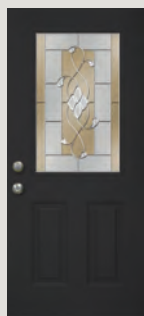

430ESZ† pg. 8

8' Essence



430ESZ pg. 20

CHEYENNE

512/513CHP ‡ † pg. 28



140CHP pg. 14 460CHP pg. 12 160CHP pg. 14



440CHP† pg. 10



430CHP† pg. 8

8' Cheyenne



430CHZ pg. 20

SYMPHONY

612/613SYA ‡ pg. 30

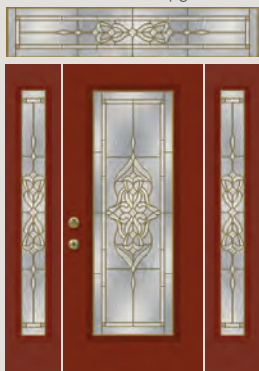

160SYA pg. 14 460SYA pg. 12 160SYA pg. 14



770SYA§ † pg. 16 440SYA† pg. 10 770SYA§ † pg. 16

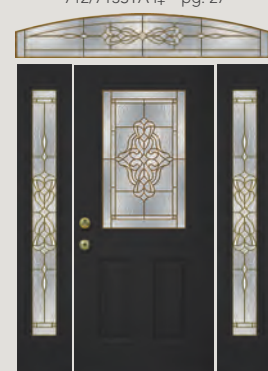

160SYA pg. 14 430SYA† pg. 8 160SYA pg. 14

532SYA* † pg. 32



712/713SYA ‡ pg. 27

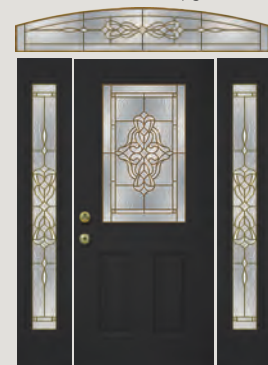

8' Symphony

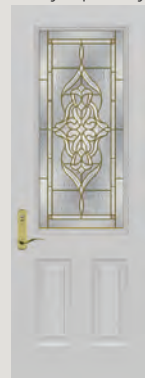

430SYA pg. 20

512/513SYA ‡ pg. 28

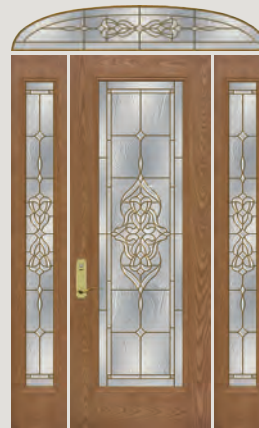

160SYA pg. 23 460SYA pg. 22 160SYA pg. 23

‡ Requires an additional 6-week lead time

† For additional door panel styles see pg. 26 (for Legacy™)

§ Also available in 10" width. See Price List for design pattern

‡ All transoms must be installed in a separate opening or use approved engineering mulls

NOTE: All doors and sidelites with glass are only available in Smooth or Woodgrain Textured Steel.

Woodgrain Textured Steel is NOT available in 8' doors and sidelites.

Direct-Set sidelites can be used with all door types.

PAGE NUMBERS REFERENCE PROVIA IMPACT SHIELD PRICE BOOK

BERKLEY

612/613BEA † pg. 30



160BEA pg. 14 460BEA pg. 12 160BEA pg. 14



770BEA§† pg. 16 440BEA† pg. 10 770BEA§† pg. 16

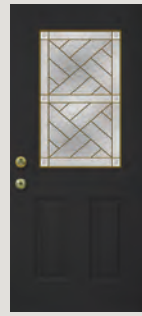

430BEA† pg. 8

8' Berkley



430BEA pg. 20

LAURENCE

612/613LAU † pg. 30

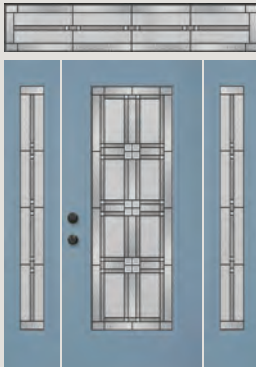

160LAU pg. 14 460LAU pg. 12 160LAU pg. 14



440LAU† pg. 10

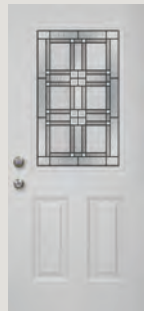

430LAU† pg. 8

8' Laurence



430LAU pg. 20

CARRINGTON

612/613CAR † pg. 30

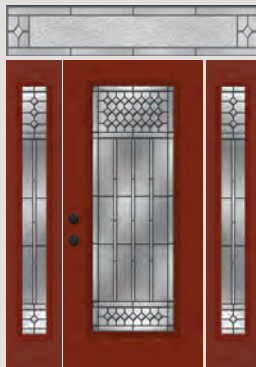

160CAR pg. 14 460CAR pg. 12 160CAR pg. 14

712/713CAR † pg. 27



770CAR§† pg. 16 440CAR† pg. 10 770CAR§† pg. 16

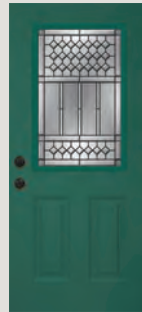

430CAR† pg. 8

8' Carrington



430CAR pg. 20

† Requires an additional 6-week lead time

‡ For additional door panel styles see pg. 26 (for Legacy™)

§ All transoms must be installed in a separate opening or use approved engineering mulls

NOTE: All doors and sidelites with glass are only available in Smooth or Woodgrain Textured Steel. Woodgrain Textured Steel is NOT available in 8' doors and sidelites. Direct-Set sidelites can be used with all door types.



PAGE NUMBERS REFERENCE PROVIA IMPACT SHIELD PRICE BOOK

TACOMA

612/613TAC ‡ pg. 30



160TAC pg. 14 460TAC pg. 12 160TAC pg. 14

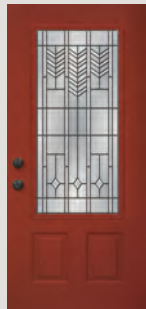

440TAC† pg. 10

8' Tacoma



430TAC pg. 20

SOMERSET

612/613SOM ‡ pg. 30



160SOM pg. 14 460SOM pg. 12 160SOM pg. 14

712/713SOM ‡ pg. 27



770SOM§ † pg. 16 440SOM† pg. 10 770SOM§ † pg. 16

512/513SOM ‡ pg. 28



160SOM pg. 14 430SOM† pg. 8 160SOM pg. 14

8' Somerset



430SOM pg. 20

CARMEN

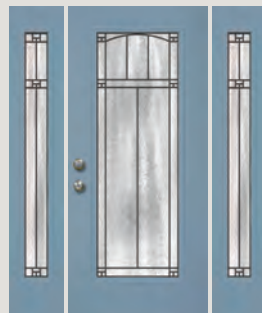

160CRM pg. 14 460CRM pg. 12 160CRM pg. 14



440CRM† pg. 10



430CRM† pg. 8

8' Carmen



430CRM† pg. 20

Note: The Outside View / Inside View photos shown below also apply to Carmen glass

BARCELONA



160BRC pg. 14 460BRC pg. 12 160BRC pg. 14

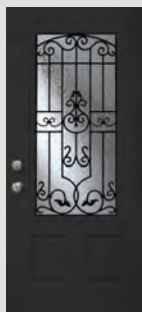

440BRC† pg. 10



430BRC† pg. 8

8' Barcelona



430BRC pg. 20



Outside View



Inside View

Note: In Impact Shield regions, the gluechip glass (or other privacy glass) is positioned to the outside face of the wrought iron.

‡ Requires an additional 6-week lead time
 † For additional door panel styles see pg. 26 (for Legacy™)
 § Also available in 10" width. See Price List for design pattern

‡ All transoms must be installed in a separate opening or use approved engineering mulls
NOTE: All doors and sidelites with glass are only available in Smooth or Woodgrain Textured Steel. Woodgrain Textured Steel is NOT available in 8' doors and sidelites. Direct-Set sidelites can be used with all door types.

PAGE NUMBERS REFERENCE PROVIA IMPACT SHIELD PRICE BOOK

CONSTANCE

612/613COB ‡ pg. 30



160COB pg. 14 460COB pg. 12 160COB pg. 14

712/713COZ ‡ pg. 27



160COZ pg. 14 440COZ † pg. 10 160COZ pg. 14

512/513COB ‡ pg. 28



770COB § † pg. 16 430COB † pg. 8 770COB § † pg. 16

TRANQUILITY

612/613TRP ‡ pg. 30

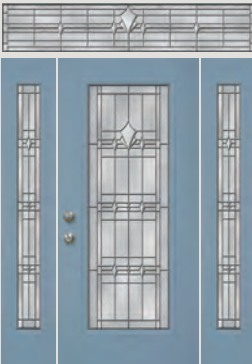

160TRP pg. 14 460TRP pg. 12 160TRP pg. 14

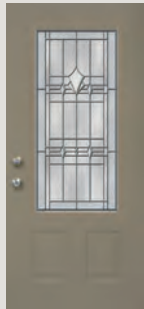

440TRP † pg. 10

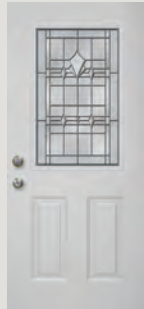

430TRP † pg. 8

8' Tranquility



430TRZ pg. 20

8' Constance



430COZ pg. 20

‡ Requires an additional 6-week lead time

† For additional door panel styles see pg. 26 (for Legacy™)

‡ All transoms must be installed in a separate opening or use approved engineering mulls

NOTE: All doors and sidelites with glass are only available in Smooth or Woodgrain Textured Steel.

Woodgrain Textured Steel is NOT available in 8' doors and sidelites.

Direct-Set sidelites can be used with all door types.



PAGE NUMBERS REFERENCE PROVIA IMPACT SHIELD PRICE BOOK

GEMSTONE

612/613GEM ‡ pg. 30

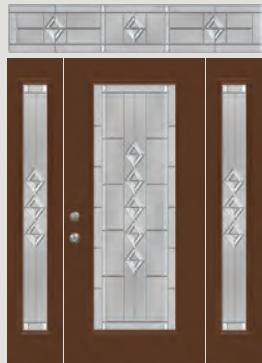

160GEM pg. 14 460GEM pg. 12 160GEM pg. 14



440GEM† pg. 10



430GEM† pg. 8

8' Gemstone



430GEM pg. 20

ECLIPSE

612/613ECB ‡ pg. 30



160ECB pg. 14 460ECB pg. 12 160ECB pg. 14

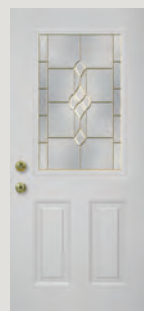

430ECB† pg. 8

FLORENCE

612/613FLP ‡ pg. 30

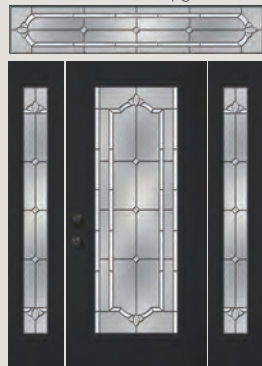

160FLP pg. 14 460FLP pg. 12 160FLP pg. 14



440FLP† pg. 10

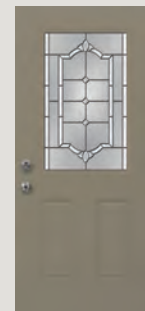

430FLP† pg. 8

8' Florence

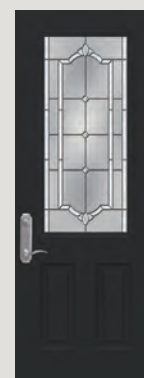

430FLP pg. 20

ESMOND

612/613ESM ‡ pg. 30

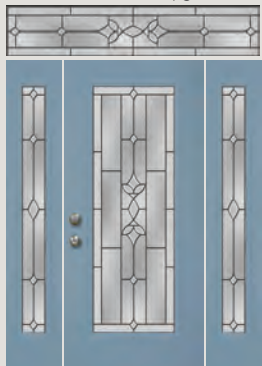

160ESM pg. 14 460ESM pg. 12 160ESM pg. 14



712/713ESM ‡ pg. 27

770ESM§ † pg. 16 440ESM† pg. 10 770ESM§ † pg. 16



512/513ESM ‡ pg. 28

160ESM pg. 14 430ESM† pg. 8 160ESM pg. 14

8' Esmond

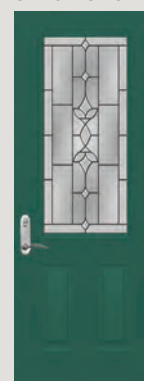

430ESM pg. 20

‡ Requires an additional 6-week lead time

† For additional door panel styles see pg. 26 (for Legacy™)

§ Also available in 10" width. See Price List for design pattern

‡ All transoms must be installed in a separate opening or use approved engineering mulls

NOTE: All doors and sidelites with glass are only available in Smooth or Woodgrain Textured Steel.

Woodgrain Textured Steel is NOT available in 8' doors and sidelites.

Direct-Set sidelites can be used with all door types.

PAGE NUMBERS REFERENCE PROVIA IMPACT SHIELD PRICE BOOK

CARLISLE



PRIVACY

8' Privacy



† Requires an additional 6-week lead time
 † For additional door panel styles see pg. 26 (for Legacy™)

‡ All transoms must be installed in a separate opening or use approved engineering mulls
NOTE: All doors and sidersites with glass are only available in Smooth or Woodgrain Textured Steel. Woodgrain Textured Steel is NOT available in 8' doors and sidersites. Direct-Set sidersites can be used with all door types.



PAGE NUMBERS REFERENCE PROVIA IMPACT SHIELD PRICE BOOK

INTERNAL GRIDS



612/613DC-IGS ‡ pg. 31



712/713DC-IGS ‡ pg. 27



512/513DC-IGS ‡ pg. 29



612/613DC-IGT ‡ pg. 31



516DC-IGS ‡ pg. 32



616DC-IGT ‡ pg. 29



532DC-IGS ‡ pg. 32



616DC-IGP ‡ pg. 29



460DC-IGT pg. 13 160DC-IGT pg. 15

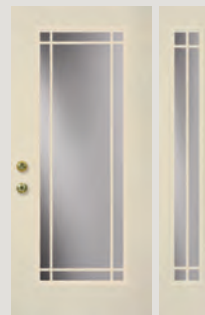

460DC-IGP pg. 13 160DC-IGP pg. 15

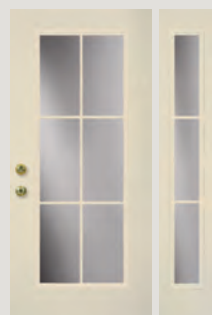

460DC-IGC pg. 13 160DC-IGC pg. 15

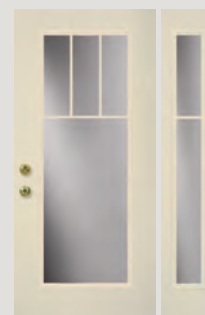

460DC-IGC-TS pg. 13 160DC-IGC-TS pg. 15

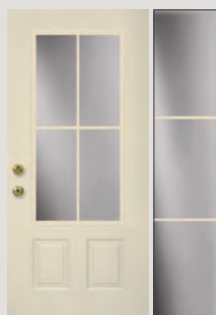

440DC-IGC† pg. 11 770DC-IGC§ pg. 17



440DC-IGT pg. 11 770DC-IGT§ pg. 17

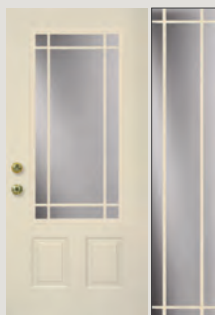

440DC-IGP† pg. 11 770DC-IGP§ pg. 17

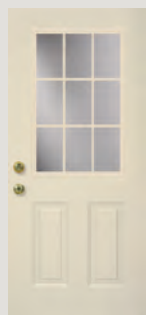

430DC-IGT† pg. 9

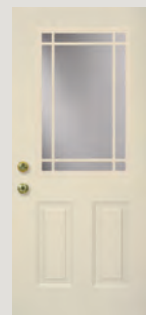

430DC-IGP† pg. 9

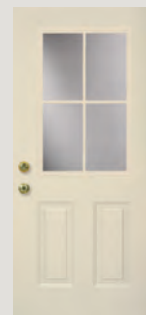

430DC-IGC† pg. 9

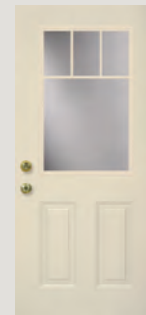

430DC-IGC-TS† pg. 9

8' Internal Grids



460DC-IGT pg. 22 160DC-IGT pg. 23



460DC-IGC pg. 22 160DC-IGC pg. 23



430DC-IGT pg. 21 770DC-IGT§ pg. 25



430DC-IGP pg. 21



430DC-IGC pg. 21 770DC-IGC§ pg. 25

† For additional door panel styles see pg. 26 (for Legacy™)
§ Also available in 10" width. See Price List for design pattern

‡ All transoms must be installed in a separate opening or use approved engineering mulls
NOTE: All doors and sidelites with glass are only available in Smooth or Woodgrain Textured Steel.
Woodgrain Textured Steel is NOT available in 8' doors and sidelites.
Direct-Set sidelites can be used with all door types.

PAGE NUMBERS REFERENCE PROVIA IMPACT SHIELD PRICE BOOK

CLEAR GLASS

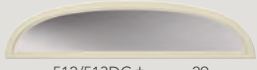

512/513DC ‡ pg. 29



712/713DC ‡ pg. 27

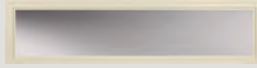

612/613DC ‡ pg. 31

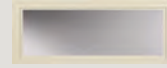

616DC ‡ pg. 29



532DC ‡ pg. 32



516DC ‡ pg. 32

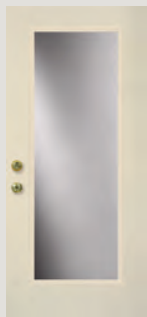

460DC
pg. 13



160DC
pg. 15

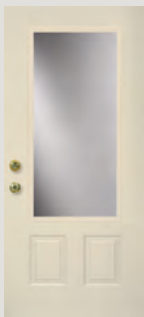

440DC †
pg. 11



770DC§
pg. 17

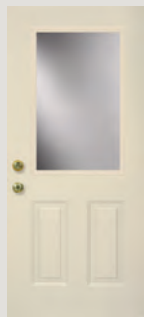

430DC †
pg. 9

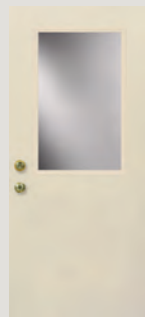

430DC-F †
pg. 9



460 Clear Glass entry systems with TLK-C are ENERGY STAR® Certified.

440 Clear Glass entry systems with TLA-C or TLK-C are ENERGY STAR Certified.

8' Clear Glass



460DC
pg. 22



160DC
pg. 23



430DC
pg. 21



770DC§
pg. 25



430DC-2P

Impact Shield

† For additional door panel styles see pg. 26 (for Legacy™)
§ Also available in 10" width

‡ All transoms must be installed in a separate opening or use approved engineering mulls
NOTE: All doors and sidelites with glass are only available in Smooth or Woodgrain Textured Steel. Woodgrain Textured Steel is NOT available in 8' doors and sidelites. Direct-Set sidelites can be used with all door types.

PAGE NUMBERS REFERENCE PROVIA IMPACT SHIELD PRICE BOOK



All Doors Without Glass are ENERGY STAR® Certified.

DOORS WITHOUT GLASS See chart on pg. 34 for style availability



8' Doors Without Glass



* Not available in Signet®

‡ All transoms must be installed in a separate opening or use approved engineering mulls

NOTE: All doors and sidelites with glass are only available in Smooth or Woodgrain Textured Steel.

Woodgrain Textured Steel is NOT available in 8' doors and sidelites.

Direct-Set sidelites can be used with all door types.

PAGE NUMBERS REFERENCE PROVIA IMPACT SHIELD PRICE BOOK

HARBOR



AMERICANA

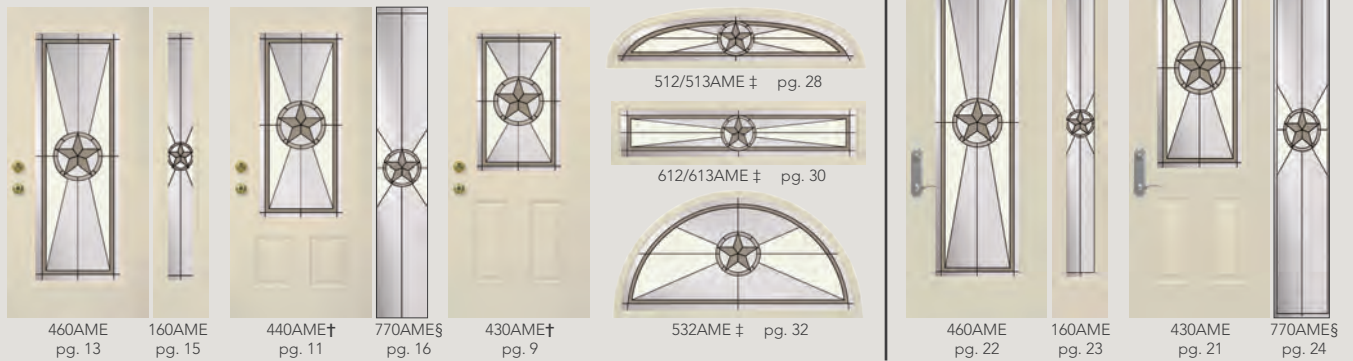

† For additional door panel styles see pg. 26 (for Legacy™)
§ Also available in 10" width. See Price List for design pattern

‡ All transoms must be installed in a separate opening or use approved engineering mulls
NOTE: All doors and sidelites with glass are only available in Smooth or Woodgrain Textured Steel. Woodgrain Textured Steel is NOT available in 8' doors and sidelites. Direct-Set sidelites can be used with all door types. 4-week lead time on all Inspirations designs



PAGE NUMBERS REFERENCE PROVIA IMPACT SHIELD PRICE BOOK

VINTAGE

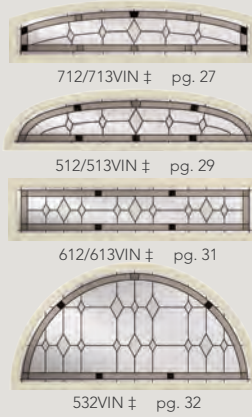

8' Vintage



LINCOLN

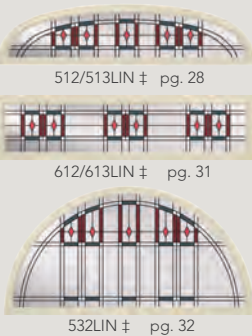

8' Lincoln

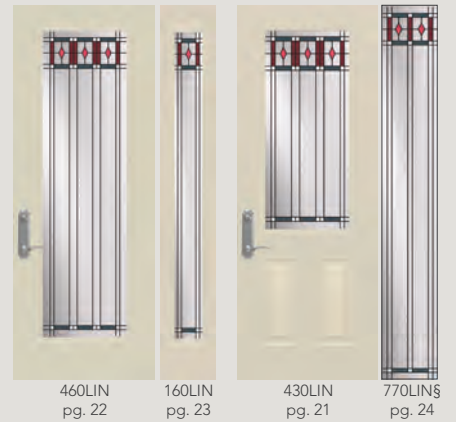

TULIPS

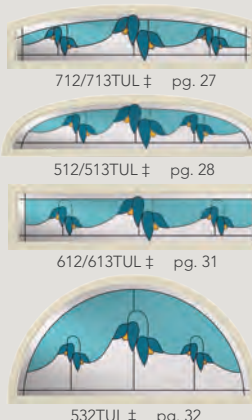

8' Tulips



† For additional door panel styles see pg. 26 (for Legacy™)
§ Also available in 10" width. See Price List for design pattern

‡ All transoms must be installed in a separate opening or use approved engineering mulls
NOTE: All doors and sidelites with glass are only available in Smooth or Woodgrain Textured Steel. Woodgrain Textured Steel is NOT available in 8' doors and sidelites. Direct-Set sidelites can be used with all door types. 4-week lead time on all Inspirations designs



460TUL, 160TUL (Vineyard)



PAGE NUMBERS REFERENCE PROVIA IMPACT SHIELD PRICE BOOK

HARMONY

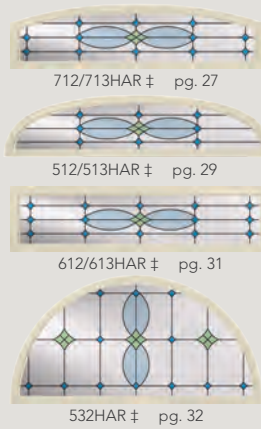

8' Harmony

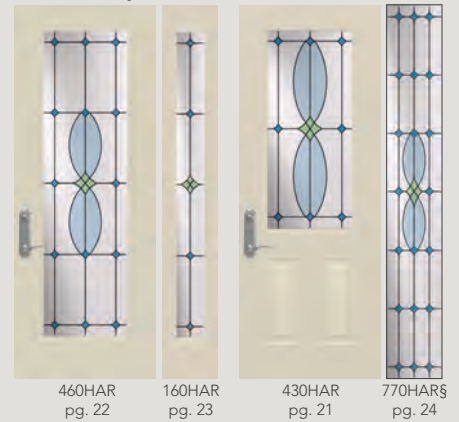

AZTEC



8' Aztec

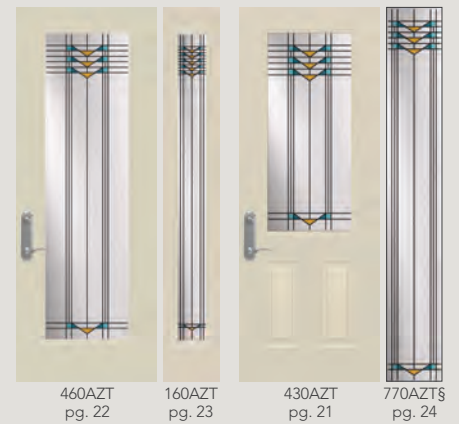

HAVEN

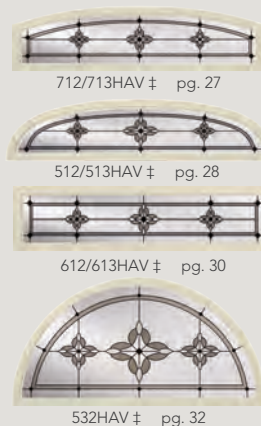

8' Haven



† For additional door panel styles see pg. 26 (for Legacy™)
§ Also available in 10" width. See Price List for design pattern

‡ All transoms must be installed in a separate opening or use approved engineering mulls
NOTE: All doors and sidelites with glass are only available in Smooth or Woodgrain Textured Steel. Woodgrain Textured Steel is NOT available in 8' doors and sidelites. Direct-Set sidelites can be used with all door types. 4-week lead time on all Inspirations designs

PAGE NUMBERS REFERENCE PROVIA IMPACT SHIELD PRICE BOOK

BLOSSOMS

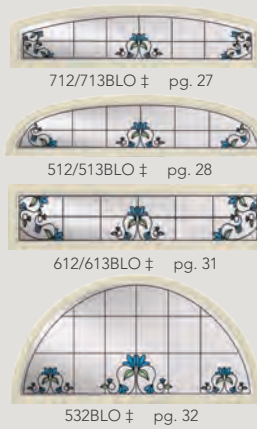

8' Blossoms



CAMBRIA



8' Cambria



WESTIN



8' Westin



† For additional door panel styles see pg. 26 (for Legacy™)
 § Also available in 10" width. See Price List for design pattern

‡ All transoms must be installed in a separate opening or use approved engineering mulls
NOTE: All doors and sidelites with glass are only available in Smooth or Woodgrain Textured Steel. Woodgrain Textured Steel is NOT available in 8' doors and sidelites. Direct-Set sidelites can be used with all door types. 4-week lead time on all Inspirations designs



460DC-IGT (Brass Pencil Grids)

FRENCH DOORS

custom size DC-IGT ‡ pg. 31



460DC-IGT
pg. 13

460DC-IGT
pg. 13

DESIGNER™ PATIO DOORS



460DC
pg. 26

460DC
pg. 26

460DC
pg. 26

460DC
pg. 26

460DC
pg. 26

VINYL SLIDING PATIO DOORS



only available in 2-lite configuration
pg. 75

‡ All transoms must be installed in a separate opening or use approved engineering mulls

NOTE: All doors and sidelites with glass are only available in Smooth or Woodgrain Textured Steel. Woodgrain Textured Steel is NOT available in 8' doors and sidelites. Direct-Set sidelites can be used with all door types.

OUR MISSION:

— TO SERVE, BY CARING FOR —

DETAILS

IN WAYS OTHERS WON'T

At ProVia, we care about our customers as much as we do the products and services we meticulously provide. We combine old-world craftsmanship with state-of-the-art technology to deliver personalized care with every order. We invite you to experience ProVia's full line of products crafted The Professional Way - which includes the industry's best in doors, windows, siding, stone and roofing.

Browse our full line of products at
provia.com





Your Vision is
Our Inspiration



WINDOWS



SIDING

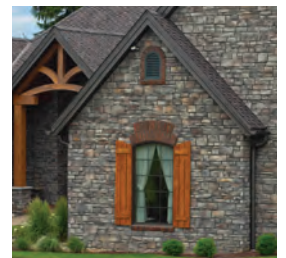

STONE



ROOFING

DOORS

provia.com



To serve, by caring for details in ways others wont. Its not just our mission, but a way of letting our light shine every day at ProVia®. We continually strive to put these words into action by providing unmatched quality and service. The P-icon symbolizes each employees commitment to devoting the utmost care, pride and quality into each building product we manufactureits The Professional Way.



At ProVia, we manufacture energy efficient products and exercise corporate environmental stewardship by recycling, reducing pollution emissions and much more. In fact, our company has received repeated awards from the Environmental Protection Agency such as Partner of the Year - Sustained Excellence for Door and Window Manufacturing.



Home Exteriors & Window Company
3606 Library Road (Rt. 88), Pittsburgh, PA

Visit our Website!

www.NewHorizonsRemodeling.com

Call us TODAY!

(412)885-1900



DOORS | WINDOWS
SIDING | STONE | ROOFING

© 2020 ProVia